

Demand Control Ventilation System Installation, Operation, and Maintenance Manual

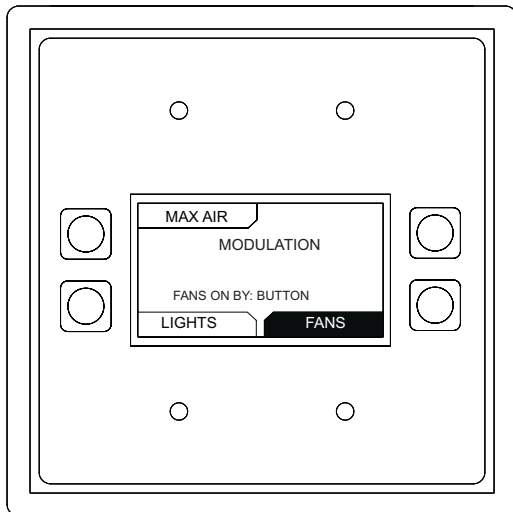

RECEIVING AND INSPECTION

Upon receiving unit, check for any interior and exterior damage, and if found, report it immediately to the carrier. Check that all accessory items are accounted for and are damage free.

WARNING!!

Installation of this equipment should only be performed by a qualified professional who has read and understands these instructions and is familiar with proper safety precautions. Improper installation poses serious risk of injury due to electric shock and other potential hazards. Read this manual thoroughly before installing or servicing this equipment. **ALWAYS** disconnect power prior to working on equipment.

Save these instructions. This document is the property of the owner of this equipment and is required for future maintenance. Leave this document with the owner when installation or service is complete.

Table of Contents

WARRANTY	4	Motor Control - Fan Zone set to Static	52
Control Specifications	4	Factory Options	53
INSTALLATION	5	Fire Options	55
Mechanical	5	Prime Surfactant	55
Site Preparation	5	Scheduling	55
Assembly	5	Light Brightness	55
ELECTRICAL	6	Selectable Fan Zone Options	57
High Voltage Wiring	7	Scheduling (Fans)	58
Low Voltage Wiring	8	Proving Enabled (Optional)	58
VFD QUICK CONNECT WIRING	10	Fan Control	60
Line Connections	10	Static Fan Zone	60
Load Connections	10	Dynamic Fan Zone	61
Installation	10	Other Options	63
Variable Frequency Drive (VFD) Installation	11	Make-Up Air Interlock	63
Input AC Power	11	Appliances Pilot Check Warning	63
VFD Output Power	12	120V AC BMS Dry Contact (Optional)	63
Variable Frequency Drive Parameters	13	Electric Gas Valve Reset	63
VFD Drive Installation & Programming	14	Wash Self-Cleaning (Optional)	64
ACTECH SMV VFD	15	Prime Surfactant	65
ECPM03 Board	16	Scheduling	65
Connector Descriptions	16	Enable Scheduling	65
ECPM03 LCD Screen	19	Occupancy Schedule	66
Changing Time Zone ID	20	Setting Wash Schedule	68
Last Fire Info	20	Copying a Schedule	69
Components	21	Setting a Continuous Schedule	70
Wireless Mini Sensor Board (WMSB)	24	Setting a Fan Schedule	70
Board Description	25	Unoccupied Additional Offset	71
Modes of Operation	26	Light Brightness	72
WMSB Installation	27	PWM 0-10V Board	72
Wall Installation	27	Diagnostics	73
J-Box Installation	27	Humidity Monitoring	73
Ambient Lighting Requirements	28	TROUBLESHOOTING CONTROL PACKAGE	74
DCV Room Temperature Logic	29	WMSB Troubleshooting	75
Electronically Commutated Motor Speed Control	29	HMI Fault Messages	76
Motor Speed Controller (MSC) Installation	31	VFD Fault List	78
MSC Controller Overview	32	MSC Troubleshooting	80
MSC Menu	33	MAINTENANCE	81
Input Threshold	35	General Maintenance	81
MSC Menu Tree	36	Every Month	81
OPERATION	37	Wall Mounted Enclosure Fan Filter Inspection	81
HMI Function	37	Self-Cleaning	81
HMI Configuration	38	Start-Up and Maintenance Documentation	84
Set Clock	39	Maintenance Record	84
ESP Dry Mode	39		
Board Settings	40		
Options	40		
Options – Board Restart	41		
Motor Control	42		
Factory Options	43		
Temperature Selection and Configuration	48		
Fire Options	49		
Menu Tree	50		
Board Settings - Options	50		
Motor Control - Fan Zone set to Dynamic	51		

WARRANTY

This equipment is warranted to be free from defects in materials and workmanship, under normal use and service, for a period of 2-years from date of shipment. This warranty shall not apply if:

1. The equipment is not installed by a qualified installer per the MANUFACTURER'S installation instructions shipped with the product.
2. The equipment is not installed in accordance with Federal, State, and Local codes and regulations.
3. The equipment is misused or neglected, or not maintained per the MANUFACTURER'S maintenance instructions.
4. The equipment is not installed and operated within the limitations set forth in this manual.
5. The invoice is not paid within the terms of the sales agreement.

The MANUFACTURER shall not be liable for incidental and consequential losses and damages potentially attributable to malfunctioning equipment. Should any part of the equipment prove defective in material or workmanship within the 2-years warranty period, upon examination by the MANUFACTURER, such part will be repaired or replaced by MANUFACTURER at no charge. The BUYER shall pay all labor costs incurred in connection with such repair or replacement. Equipment shall not be returned without MANUFACTURER'S prior authorization, and all returned equipment shall be shipped by the BUYER, freight prepaid to a destination determined by the MANUFACTURER.

NOTE: To receive warranty coverage, register this product by filling out the "Start-Up and Maintenance Documentation" on page 84. Fax the form to 1-919-554-9374 or call 1-866-784-6900 for email information.

Control Specifications

The control package may be ordered as a Demand Control Ventilation (DCV), Smart Control (SC), Mixed Demand Control Ventilation (M-DCV), or Residential Hood (Residential-Hood). These systems are designed to control, activate, and operate the exhaust fan(s), supply fan(s), CORE system(s), and wash system dependent on the HMI settings and temperature sensors. The system can have up to two zones that the fans are assigned to. Each fan zone has several parameters that communicate with the system on how to operate.

INSTALLATION

It is imperative that this unit is installed and operated with the designed airflow and electrical supply in accordance with this manual and applicable codes. If there are any questions about any items, please call the service department at **1-866-784-6900** for warranty and technical support issues.

Mechanical

WARNING: DO NOT LIFT CONTROL PANEL BY COMPONENT WIRING.

Site Preparation

1. Provide clearance around installation site to safely install equipment into its final position. Supports must adequately support equipment.
2. Consider general service and installation space when locating unit.

Assembly

When the control panel is ordered in a utility cabinet installed on the hood, there is some field assembly required by the installer. If the control panel is ordered as a wall-mounted panel, the enclosure must be secured to a fixed wall near the equipment. **Verify there is adequate clearance from excessive heat sources such as appliances to prevent damage to the components.** Check local and national electrical code(s) for clearance requirements in front of the panel, typically 36". Refer to **Figure 1** for common installation scenarios.

Figure 1 - Control Panel Mount Installations

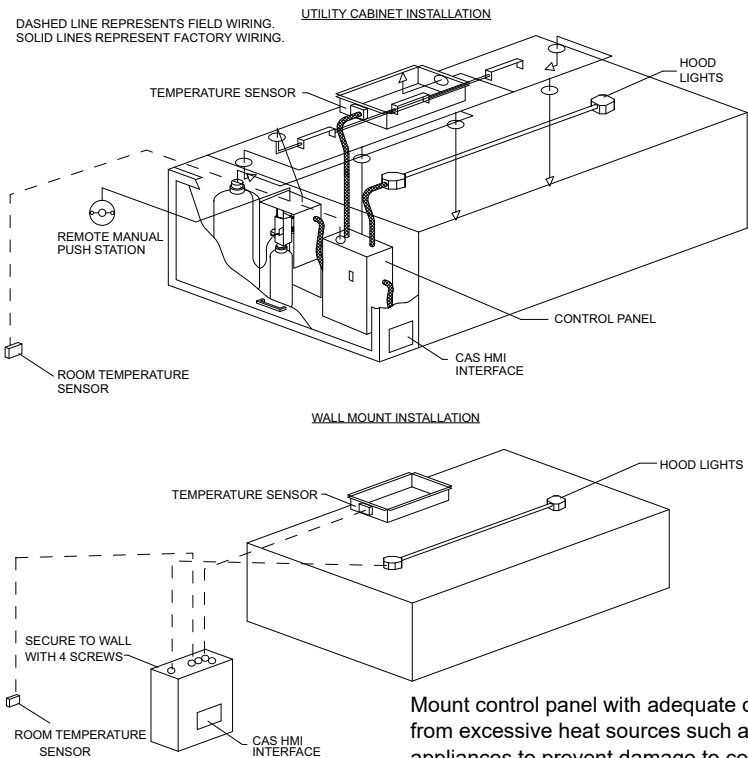

ELECTRICAL

WARNING!!

Disconnect power before installing or servicing unit. High voltage electrical input is needed for this equipment. A qualified electrician should perform this work.

Before connecting power to the package, read and understand the entire section of this document. As-built wiring diagrams are furnished with each unit by the factory. They are attached to the control module's door or provided with paperwork packet.

Electrical wiring (**Table 1**) and connections must be made in accordance with local ordinances and the National Electric Code, ANSI/NFPA 70. Verify the voltage and phase of the power supply, and the wire amperage capacity is in accordance with the unit nameplate. For additional safety information, refer to AMCA publication 410-96, *Recommended Safety Practices for Users and Installers of Industrial and Commercial Fans*.

1. **Always disconnect power before working on or near this equipment. Lock and tag the disconnect switch and/or breaker to prevent accidental power-up.**
2. Verify that the power source is compatible with the requirements of your equipment. The nameplate identifies the **proper phase and voltage** of the equipment.
3. Before connecting the unit to the building's power source, verify that the power source wiring is de-energized.
4. Secure the power cable to prevent contact with sharp objects.
5. Do not kink power cable and never allow the cable to encounter oil, grease, hot surfaces, or chemicals.
6. Before powering up the unit, verify that the fan rotates freely. Make sure that the interior of the unit is free of loose debris or shipping materials.
7. If any of the original wire supplied with the unit must be replaced, it must be replaced with type THHN wire or equivalent.

Table 1 - Copper Wire Ampacity

Wire Size AWG	Maximum Amps	Wire Size AWG	Maximum Amps
14	15	4	85
12	20	3	100
10	30	2	115
8	50	1	130
6	65		

High Voltage Wiring

- All high voltage wiring shall be connected on the open side of the vertical terminal blocks located on the right-hand side of the panel. The right side knockouts should be utilized for high voltage connections.
- Variable frequency drives will have quick connectors for their line and load power. The load wiring must not share conduit with other motor load wiring. Each motor must have its own conduit, or the warranty is void.
- There are multiple electrical power sources required for this control panel. Refer to installation diagrams inside the panel for details.
- The hood light wiring will also need to be wired to terminals, as indicated on the the installation diagram.
- If an ANSUL fire system is present, the fire system micro-switch will need to be wired to terminals as indicated on the installation diagram, typically "C1" and "AR1". C1 is common and connects to terminal 1 on the micro-switch. AR1 is the armed state and connects to terminal 2 on the micro-switch.

Figure 2 - Typical Cabinet Layout

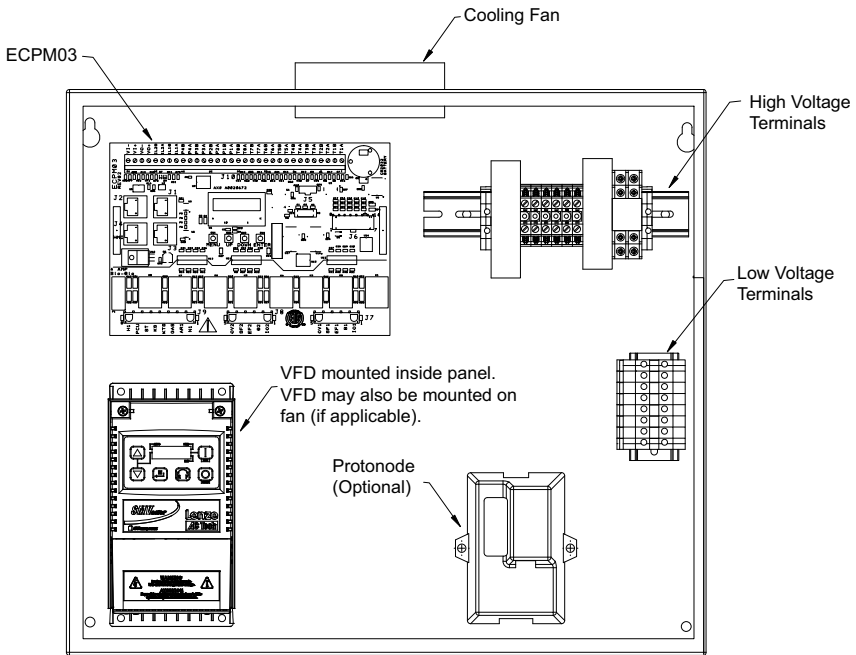

Low Voltage Wiring

Low voltage wiring should be run through the left side knockouts on the panel. Do not route low voltage wiring in the same conduit as high voltage wiring. Low voltage wiring typically terminates directly on the control board or components.

- **Room Temperature Sensor(s):** For all installations, at least 1 room temperature sensor must be installed in a safe location. Locate the sensor so that it is free from external heat sources that may affect the sensor readings. It should be indicative of the average room/space temperature and kept away from appliances or heat emitting equipment. 2-wire 18 AWG thermistor cable must be used. The room temperature sensor shall be wired according to the installation wiring schematic, terminals **T1A**, and **T1B**.
- **Temperature Sensors:** For all installations that include the thermostatically controlled option, temperature, or duct mounted sensors will need to be wired in the field. 2-wire 18 AWG plenum-rated thermistor cable must be used and is typically provided. The temperature sensor(s) should be wired to terminal block inputs designated as TxA and TxB. The “x” indicates the temperature input sensor number.
- **Wireless Mini Sensor Board (WMSB):** For all installations, remote WMSB must be installed in a safe location. Locate the sensor(s) so that they are free from external heat sources that may affect the sensor readings. The solar cell requires 200 lumens per sq. foot or 20 foot candles. The location should be indicative of the average room temperature and relative humidity, and kept away from appliances. Refer to “**Ambient Lighting Requirements**” on page 28.
- **HMI:** The HMI is connected to the ECPM03 board through a **Cat 5** cable. The HMI has two RJ-45 connectors. The HMI connects to either port J4 or J5 (RJ-45) of the ECPM03 board. The other RJ-45 port of the HMI will typically be occupied by an RJ-45 end-of-line terminator. If more than one HMI is included, each HMI must be daisy-chained together to form a loop, with the end-of-line terminator installed at the last HMI. Up to 4 HMIs are possible.
- **VDC Output:** Provides a **0-10V DC** or **2-10V DC** signal to provide a linear representation of exhaust or supply motor speed and light dimming capabilities. This connection can be wired to a Variable Frequency Drive (VFD) that accepts 0-10V DC or 2-10V DC as an input. The 0-10V DC output is generated directly on the control board at terminals VO+ and VO-.
- **Motor Control Pulse Width Modulation (PWM) Outputs:** Provides a **24V DC** signal that can be used to drive an Electrically Commutated Motor (ECM) at a programmed duty cycle. The duty cycle determines the on and off time of a signal to the armature of the motor. PWM outputs should be wired with 18 AWG shielded twisted pair cable. PWM outputs are located at terminals PxA and PxB. These should be wired directly to the connector on the ECM fan motor harness.
- **MUA Interlock:** The Make-Up Air (MUA) interlock is to prove that the safety controls (freezestat, smoke detector, etc.) are satisfied, and the supply damper is open. The MUA safety connections should be wired in series to their zone-based interlock assignment. If the system is set to supply share static or supply share dynamic, the supply interlock will only be associated with **IL1A** and **IL1B**.
- **24V DC Relay Outputs:** Relay outputs are programmed for various different functions. RO1 and RO2 can be used to activate a lighting circuit corresponding to fan zone 1 and fan zone 2. RO3 can be used to give an indication that there is a fault on the board. RO4 and RO5 can be used to activate a relay when the fans are in a particular state (see Fan Status Relay 4/5 on page 40). RO6 is an indication of when either of the zones are on by modulation. In certain cases, RO6 is used to drive the cooling panel fan.

- **End-Of-Line Resistors:** Several end-of-line resistors are included in each panel. The purpose of the end-of-line resistor is to filter out reflections that can cause distortion to the source waveform. Be sure that the end-of-line is terminated to avoid network issues. They are typically plugged in at the factory on port J3 or port J4, or in the back of the first HMI. If another HMI or other equipment needs to connect to a port occupied by an end-of-line terminator, it should be removed and placed on the HMI or equipment that became connected at the end of the Modbus network.
- **Other:** If other pieces of equipment, such as a PCU Advanced Filter Monitoring (AFM) system, are connected to this panel, a **Cat 5** cable will be used to run the Modbus communication between these devices. The cable should be plugged in port J3 of the ECPM03 board. The end-of-line terminators should then be relocated from J3 to the last device on the line.

VFD QUICK CONNECT WIRING

CAUTION! Improper installation poses serious risk of injury due to electric shock and other potential hazards. Read product manual(s) and wiring schematics thoroughly before installing or servicing equipment. ALWAYS disconnect power before working on equipment.

When wiring the VFD into the Electrical Control Package (ECP), the quick connectors will be shipped loose for installation. The LINE connectors will mount on the upper DIN rail, and the LOAD connectors will mount on the bottom DIN rail. Refer to **Figure 3**.

Line Connections

The LINE connector uses two keys, both are located on the right side of the connector. The loose LINE connections will be made from the breaker panel.

Load Connections

The LOAD connector uses two keys, one on the left and the other on right side of the connector. The loose LOAD connections will be made from the motor.

Installation

1. Locate the loose LINE connector(s).
2. Install wiring from the breaker to the loose LINE connector. Before making connections, verify the voltage at the LINE connector. **DO NOT CONNECT THE LINE CONNECTIONS UNTIL THE INCOMING VOLTAGE IS VERIFIED.**
3. Connect the LINE connections.
4. Locate the loose LOAD connector(s).
5. Install wiring from the motor to the loose LOAD connector. **DO NOT CONNECT THE LOAD CONNECTIONS UNTIL THE WIRING IS VERIFIED.**
6. Connect the LOAD connections.

Figure 3 - Electrical Package VFD Connections

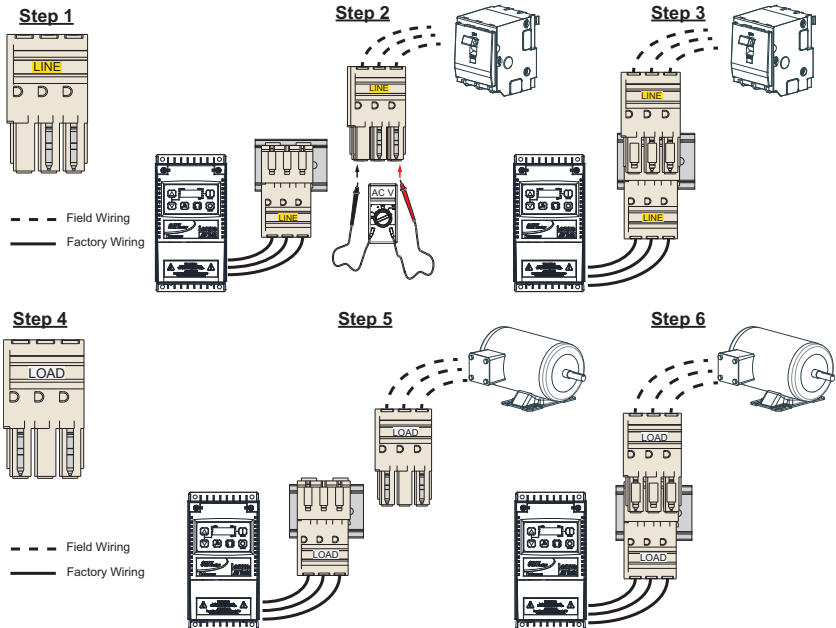

Variable Frequency Drive (VFD) Installation

Variable Frequency Drives (VFDs) change the speed of 3-phase motors by varying the frequency signal sent to the motor. Refer to the factory wiring schematics to determine which fans are controlled by VFDs. VFDs are referenced on the wiring schematics as SM-x. Two RJ-45 plugs are used to connect the drives to each other and to the ECPM03 control board through Cat 5 cables.

The load wiring from variable frequency drives must be run in its own conduit. Each motor should not share load wiring conduit with any other motor covered by a variable frequency drive.

Input AC Power

- Circuit breakers feeding the VFDs are recommended to be thermal-magnetic and fast-acting. They should be sized based on the VFD amperage and according to **Table 3 on page 15**. Refer to the installation schematic for exact breaker sizing.
- Every VFD should receive power from its own breaker. If multiple VFDs are to be combined on the same breaker, each drive should have its own protection measure (fuses or miniature circuit breaker) downstream from the breaker.
- Input AC line wires should be routed in conduit from the breaker panel to the drives. AC input power to multiple VFDs can be run in a single conduit if needed. **Do not combine input and output power cables in the same conduit.**
- The VFD should be grounded on the terminal marked PE.
- A separate insulated ground wire must be provided to each VFD from the electrical panel. This will reduce the noise being radiated in other equipment.

ATTENTION: Do not connect incoming AC power to output terminals U, V, W. Severe damage to the drive will result. Input power must always be wired to the input L terminal connections (L1, L2, L3).

VFD Output Power

- Motor wires from each VFD to its respective motor **MUST** be routed in a **separate steel** conduit away from control wiring and incoming AC power wiring. This is to avoid noise and crosstalk between drives. An insulated ground must be run from each VFD to its respective motor. Do not run different fan output power cables in the same conduit.
- VFD mounted in ECP: A load reactor should be used and sized accordingly when the distance between the VFD and motor is greater than specified below. The load reactor should be installed within 10 feet of the VFD output:
 - **208/230V** - Load reactor should be used when distance exceeds 250 feet.
 - **460/480V** - Load reactor should be used when distance exceeds 50 feet.
 - **575/600V** - Load reactor should be used when distance exceeds 25 feet.
- VFD mounted in fan: The load reactor should be sized accordingly when the VFD is mounted in the fan.
 - **208/230V** - Load reactor is optional but recommended for 15 HP and above motors.
 - **460/480V** - Load reactor is optional but recommended for 7.5 HP and above motors.
 - **575/600V** - Load reactors are required for all HP motors.
- If the distance between the VFD and the motor is extremely long, up to 1000 FT, a dV/dT filter should be used, and the VFD should be increased by 1 HP or to the next size VFD. The dV/dT filter should be sized accordingly and installed within 10 feet of the output of the VFD.
 - **208/230V** – dV/dT filter should be used when distance exceeds 400 feet.
 - **460/480V** – dV/dT filter should be used when distance exceeds 250 feet.
 - **575/600V** – dV/dT filter should be used when distance exceeds 150 feet.
- Do not install a contactor between the drive and the motor. Operating such a device while the drive is running can potentially cause damage to the power components of the drive.
- When a disconnect switch is installed between the drive and motor, the disconnect should only be operated when the drive is in a STOP state.

Variable Frequency Drive Parameters

Variable frequency drive parameters can be changed with the buttons on the face of the drive. Only parameters P107 (line voltage selection) and P108 (motor overload) should be adjusted in the field, if needed. All other settings can be adjusted through the HMI.

To enter the PROGRAM mode to access the parameters:

1. Press the **Mode (M)** button.
2. The display will read "P100". If prompted for a password (PASS), use the **Up** and **Down** buttons to scroll to the password value (the factory default password is "0225") and press the **Mode (M)** button. Once the correct password is entered, the display will read "P100", which indicates that the PROGRAM mode has been accessed at the beginning of the parameter menu.
3. Use the **Up** and **Down** buttons to scroll to the desired parameter number.
4. Once the desired parameter is found, press the **Mode (M)** button to display the present parameter setting. The parameter value will begin blinking, indicating that the present parameter setting is being displayed. The value of the parameter can be changed by using the **Up** and **Down** buttons.
5. Pressing the **Mode (M)** button will store the new setting and exit the PROGRAM mode. To change another parameter, press the **Mode (M)** button again to re-enter the PROGRAM mode. If the **Mode (M)** button is pressed within 1 minute of exiting the PROGRAM mode, the password is not required to access the parameters. After one minute, the password must be re-entered in order to access the parameters again.

Figure 4 - VFD Screen

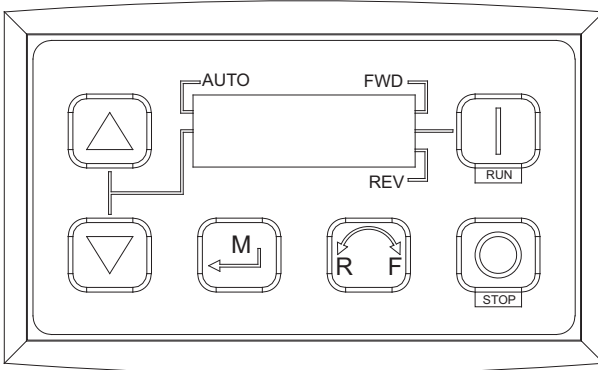

- **P100** is how the user sets the VFD start control. The user may set this to 0 (default) and may use the **RUN** button to start the drive. Setting 4 allows the start control to be switched between a terminal strip and local keypad.
- **P102** is the minimum frequency setting based on motor and fan limitations.
- **P103** is the maximum frequency setting based on motor and fan limitations. The hertz cannot go below the minimum frequency (P102).
- **P107** is set to 0 (Low) if motor voltage is **120V AC**, **208V AC** or **400V AC**. P107 is set to 1 (High) if motor voltage is **230V AC**, **480V AC** or **575V AC**.
- **P108** is calculated as $\text{Motor FLA} \times 100 / \text{Drive Output Rating}$ available in **Table 3 on page 15**.
- **P167** is the rated motor frequency for standard applications. The base frequency default setting is 60 Hz.
- **P194** = Password 0225

- **P410** = Modbus Address of the VFD.
- **P500** parameter provides a history of the last 8 faults on the drive. It can be accessed without getting into PROGRAM mode.
- **P512** is for checking heat sink temperature.

NOTE: P108 should not be adjusted unless the motor FLA does not match the nameplate FLA as specified in the field wiring schematics.

Refer to “VFD Fault List” on page 78 for common faults and troubleshooting guidance.

VFD Drive Installation & Programming

WARNING!!
Before installing the VFD drive, ensure the input power supply to the drive is OFF. The power supply and motor wiring of the VFD must be completed by a qualified electrician.
The VFD is factory programmed, only change if replaced or ordered separately.

Consult the VFD manual and all documentation shipped with the unit for proper installation and wiring of the VFD. The VFD has been programmed by the factory with ordered specific parameters.

Table 2 - VFD Installation Check List

Check Off	Description
	The installation environment conforms to the VFD manual.
	The drive is mounted securely.
	Space around the drive meets the drive’s specification for cooling.
	The motor and driven equipment are ready to start.
	The drive is properly grounded.
	The input power voltage matches the drive’s nominal input voltage.
	The input power connections at L1, L2, and L3 are connected and tight.
	The input power protection is installed.
	The motor power connection at U, V, and W are connected and tight.
	The input, motor, and control wiring are run in separate conduit runs.
	The control wiring is connected and tight.
	NO tools or foreign objects (such as drill shavings) are in the drive.
	NO alternative power source for the motor (such as a bypass connection) is connected - NO voltage is applied to the output of the drive.

ACTECH SMV VFD

Table 3 - VFD Cross-Reference Table

HP	Part Number	Volts	1Ø Input	3Ø Input	Input Amps 1Ø	Input Amps 3Ø	Output Amps	Breaker 1Ø	Breaker 3Ø
0.5	ESV371N02YXB571	240V	X	X	5.1	2.9	2.4	15	15
1	ESV751N02YXB571	240V	X	X	8.8	5	4.2	15	15
1.5	ESV112N02YXB571	240V	X	X	12	6.9	6	20	15
2	ESV152N02YXB571	240V	X	X	13.3	8.1	7	25	15
3	ESV222N02YXB	240V	X	X	17.1	10.8	9.6	30	20
5	ESV402N02TXB	240V	-	X	-	18.6	16.5	-	30
7.5	ESV552N02TXB	240V	-	X	-	26	23	-	40
10	ESV752N02TXB	240V	-	X	-	33	29	-	50
15	ESV113N02TXB571	240V	-	X	-	48	42	-	80
20	ESV153N02TXB571	240V	-	X	-	59	54	-	90
1	ESV751N04TXB571	480V	-	X	-	2.5	2.1	-	15
1.5	ESV112N04TXB571	480V	-	X	-	3.6	3	-	15
2	ESV152N04TXB571	480V	-	X	-	4.1	3.5	-	15
3	ESV222N04TXB571	480V	-	X	-	5.4	4.8	-	15
5	ESV402N04TXB571	480V	-	X	-	9.3	8.2	-	15
7.5	ESV552N04TXB571	480V	-	X	-	12.4	11	-	20
10	ESV752N04TXB571	480V	-	X	-	15.8	14	-	25
15	ESV113N04TXB571	480V	-	X	-	24	21	-	40
20	ESV153N04TXB	480V	-	X	-	31	27	-	50
25	ESV183N04TXB571	480V	-	X	-	38	34	-	70
30	ESV223N04TXB571	480V	-	X	-	45	40	-	80
1	ESV751N06TXB571	600V	-	X	-	2	1.7	-	15
2	ESV152N06TXB571	600V	-	X	-	3.2	2.7	-	15
3	ESV222N06TXB571	600V	-	X	-	4.4	3.9	-	15
5	ESV402N06TXB	600V	-	X	-	6.8	6.1	-	15
7.5	ESV552N06TXB571	600V	-	X	-	10.2	9	-	20
10	ESV752N06TXB	600V	-	X	-	12.4	11	-	20
15	ESV113N06TXB571	600V	-	X	-	19.7	17	-	30
20	ESV153N06TXB571	600V	-	X	-	25	22	-	40
25	ESV183N06TXB571	600V	-	X	-	31	27	-	50
30	ESV223N06TXB	600V	-	X	-	36	32	-	60

ECPM03 Board

ECPM03 is the primary control of the system. It receives all digital and analog inputs, and delivers all digital outputs for external devices.

NOTE: Not all pins or electrical features may be used with your electrical control package. Verify with wiring schematics and/or HMI settings.

Connector Descriptions

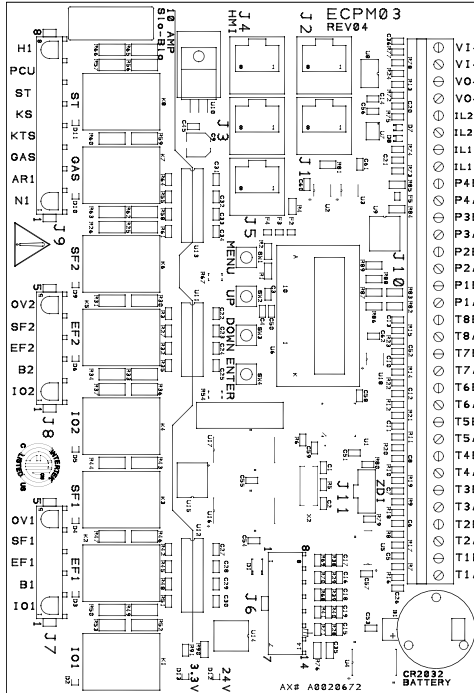

RJ45 Connectors

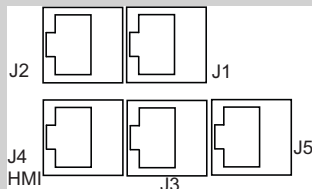

J1, J2 - Modbus master network connectors, feed through RJ45s, which conform to the Modbus pin-out for RS485 2 wire differential Modbus RTU standard. J1 and J2 are utilized for Comm Module and external BMS interface. No field wires should be connected to J1 or J2.

J3, J4, J5: Modbus slave network connectors feed through RJ45s, which conform to the Modbus pin-out for RS485 2 wire differential Modbus RTU standard. Modbus communication is not configured for third party integration without additional components. All network, PCU AFM, HMI, and VFDs report through J3, J4 and J5. The order of connection is irrelevant. See <http://www.modbus.org>

Connector J6 contains factory only wiring for low voltage connections

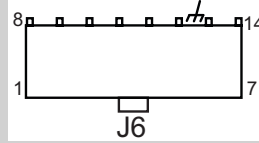

Pin 1 - **24V DC** power input (positive side) to the board.

Pin 2 through pin 7 - Each open collector relay output (RO) sources **100 mA** max and is suitable for driving **24V DC** relays or indicator lamps.

Pin 8 through pin 12 - **4-20 mA** current inputs. 150 Ohm impedance to **24V DC** ground pin 14.

Pin 13 - Chassis ground connection, this pin connects to the **24V DC** ground through a paralleled 1000pf **2000V** capacitor and a 100k Ohm 1/4W resistor.

Pin 14 - **24V DC** power input (negative side) to the board. Ground or common side of the low voltage circuitry.

Connector J7 contains **120V**

AC control connector for factory only wiring

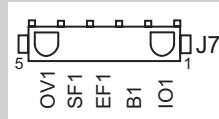

Pin 1 - (IO1) output and input can source **120V AC** and detect the presence of **120V AC**.

Pin 2 - (B1) input can detect the presence of **120V AC**.

Pin 3 - (EF1) output and input can source **120V AC** and detect the presence of **120V AC**.

Pin 4 - (SF1) output can source **120V AC**.

Pin 5 - (OV1) input can detect the presence of **120V AC**.

Connector J8 contains **120V**

AC control connector for factory wiring

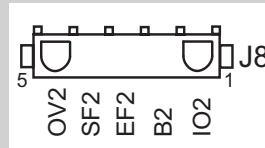

Pin 1 - (IO2) output and input can source **120V AC** and detect the presence of **120V AC**.

Pin 2 - (B2) input can detect the presence of **120V AC**.

Pin 3 - (EF2) output and input can source **120V AC** and detect the presence of **120V AC**.

Pin 4 - (SF2) output can source **120V AC**.

Pin 5 - (OV2) input can detect the presence of **120V AC**.

Connector J9 contains **120V**

AC control connector for factory only wiring

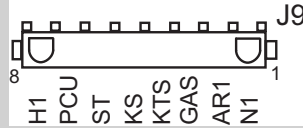

Pin 1 - (N1) is the neutral or return path for the detection of **120V AC** by the input pins. It would be connected to the neutral side of the **120V AC** supply.

Pin 2 - (AR1) input can detect the presence of **120V AC**.

Pin 3 - (GAS) output can source **120V AC**.

Pin 4 - (KTS) input can detect the presence of **120V AC**.

Pin 5 - (KS) output can source **120V AC**.

Pin 6 - (ST) output can source **120V AC**.

Pin 7 - (PCU) input can detect the presence of **120V AC**.

Pin 8 - (H1) is the **120V AC** 50/60Hz input to the board, it feeds through an on-board 10 Amp Slow-Blow fuse and is used to source **120V AC** to all the pins described as **120V AC** outputs. The total current draw of all the **120V AC** outputs must not exceed 10 Amps.

Connector J10 contains low voltage field wiring connections

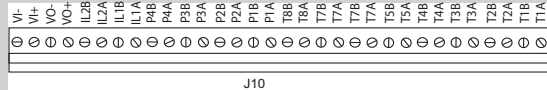

Pin 1 through pin 16 - thermistor probe inputs. 10k type B thermistors are connected to these inputs.

Pin 17, 19, 21, 23, 25, and 27 - sources **24V DC** which is current limited through an onboard **200 mA** PTC Poly-Fuse. This is the high side of the pulse width modulated outputs, and low voltage inputs listed below.

Pin 18, 20, 22, and 24 - Open collector PWM outputs, **100 mA** max each. Suitable for driving the optoisolated PWM speed control inputs of EC motors.

Pin 26, 28 - low voltage inputs, suitable for detecting dry contact closures with pins 25, 27 above.

Pin 29 - **0-10V DC** output, **5 mA** max, suitable for driving instrumentation inputs.

Pin 30 - negative, common or ground side of the above **0-10V DC** output.

Pin 31 - **0-10V DC** input, 10k Ohm impedance to ground or common.

Pin 32 - negative, common or ground side of the above **0-10V DC** output.

Connector J11 factory programming only, Zilog ZDI micro-controller debug/programming interface

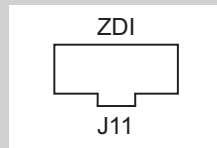

Pin 1 - **3.3V DC**

Pin 2 - reset

Pin 3 - Gnd

Pin 4 - DBG input

Pin 5 - Gnd

Pin 6 - NC

ECPM03 LCD Screen

The ECPM03 board allows the user to monitor the system and configure a broad range of options associated with the functionality of the system.

The ECPM03 LCD (**Figure 5**) has 4 buttons for navigation: **MENU**, **UP**, **DOWN**, **ENTER**. When in configuration mode, the four buttons on the HMI will be labeled the same.

The **MENU** button typically takes moves up one level in the menu tree. The **ENTER** button moves down one level. The **UP** and **DOWN**

buttons navigate through the same level of the menu tree and allows the user to change the value of a parameter.

Figure 5 - ECPM03 LCD Screen

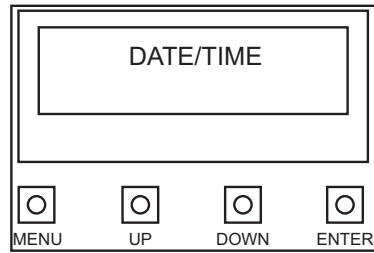

NOTE: A reboot of the board will cause the electric gas valve (if equipped) to shut off. Confirm that gas/pilot lights are re-lit if necessary. It will also cause the VFDs to stop if not in auto mode.

The following parameters can be accessed through the ECPM03 board:

- Temperature - Allows the user to view all temperatures measured by the room, duct, and temperature sensors.
- Faults - Allows the user to "View Faults," "Last Fire Info (**page 20**)," or "Clear Faults."
- System Bypass - This option is designed to bypass the system and have the fans running at their max designed CFM. This function can be utilized for Test and Balance purposes. Starting from the main menu, press the **DOWN** button until the screen displays "System Bypass." Press the **ENTER** button. Press the **UP** or **DOWN** buttons to activate or deactivate system bypass. Press enter to save the selection.
- Fan Monitoring and Motor Amps - Starting from the main menu, press the **DOWN** button until the screen displays "Fan Monitoring." Press the **ENTER** button. Press the **UP** and **DOWN** buttons to alternate between "Fan Frequencies" and "Motor Amps." Press **ENTER** for either one to view "Frequency" of each VFD or amps drawn by the motor on each fan.

NOTE: Fans controlled by contactors or via PWM output will not have an amp or frequency value.

- Proving Calibration - When proving is enabled, Calibration is required at start-up. To perform the calibration procedure, make sure a Test and Balance has been performed on the entire system first. Filters should be in place.
 - Starting from the main menu, press **DOWN** until the screen displays "Calibration." Press **ENTER**. The screen should display "Proving Calib. Calibrate?" Press **ENTER** again to start the calibration process, the calibration takes approximately 2 minutes and 30 seconds.
 - Press **MENU** one time when calibration is complete. If calibration is unsuccessful, the message "Calibration Fail" will appear. Verify the VFDs are running, current sensor assignments are properly set to the Electronically Commutated Motor(s) (ECM), zones, and contactors. Check that the Make-Up Air (MUA) interlock signals are wired correctly to terminal pins ILxA and ILxB.

Changing Time Zone ID

Use the ECPM03 board menu to change the time zone (**Figure 6**).

- Use the **UP** or **DOWN** buttons to scroll to the “Date/Time” menu. Press **ENTER**.
- The current time zone parameter is shown. Press **UP** or **DOWN**.
- “Change Time Zone?” is now displayed. Press **ENTER**.
- Scroll until the correct time zone is found.

The “Offset” parameter is based on Universal Coordinated Time (UTC). Time zones that observe Daylight Savings Time (DST) are programmed to follow this schedule. Time zones that do not observe DST, are programmed to follow their standard time setting.

The most common time zones used are:

ID: 3 (UTC -10:00) Hawaii Time – (DST - No)

ID: 4 (UTC -09:00) Alaskan Time – (DST - Yes)

ID: 6 (UTC -08:00) Pacific Time – US & Canada (DST - Yes)

ID: 7 (UTC -07:00) Mountain Time – Arizona (DST - No)

ID: 9 (UTC -07:00) Mountain Time – US & Canada (DST - Yes)

ID: 11 (UTC -06:00) Central Time – US & Canada (DST - Yes)

ID: 16 (UTC -05:00) Eastern Time – US & Canada (DST - Yes)

Figure 6 - Time Zone

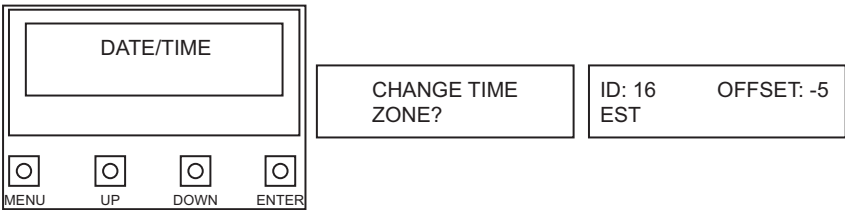

Last Fire Info

When viewing information from the “Last Fire Info” screen, the user may see the following:

- Date of when the fire activation occurred.
- Time of when the fire activation occurred.
- If the activation occurred through manual activation or a firestat.
- If the system was in Test or Armed mode when the activation occurred.
- Up to 32 temperature sensor readings are displayed on the ECPM03 board. If a temperature sensor is not connected, N/A will be displayed.

To cycle through the menus, press up once to view activation and mode status. Press up again to view temperature readings.

Components

HMI

The HMI (**Figure 7**) is designed to withstand grease and water. The main HMI is normally installed on the face of the hood or utility cabinet. HMIs have a built-in temperature sensor, which is typically used to help monitor or control the automatic functions of the unit. The HMI can be ordered to have a humidity sensor option. If this option is present, the system can display humidity readings. This option should be placed in a location where there are no cooking operations to obtain an accurate humidity reading. **Do not mount an HMI used for humidity readings onto the hood.**

The interface is connected to the ECPM03 through a Cat 5 cable. If the interface is installed on the face of the hood, a high-temperature Cat 5 cable is used.

The HMI can be mounted to a standard 2-gang junction box. Do not use junction boxes with rounded corners.

If the HMI is not attached to the hood, the HMI can be used as a room temperature sensor for a fan zone. If the HMI is used as a temperature sensor, do not mount the HMI on the hood to avoid false temperature readings. It is suggested that the HMI be mounted in a wall-mounted gang box away from external heat sources.

Room Temperature Sensor

The Room Temperature Sensor (**Figure 7**) is a 10K ohm type-2 thermistor. The sensor provides room temperature reading to the control board. The sensor should be installed on a wall within the space but not directly under the hood or close to an appliance. Sensor readings may be affected by heat.

Typically, a system will have one room temperature sensor. However, systems configured with 2 fan zones have the option to be ordered with 2 room temperature sensors, one for each zone. They should be mounted in the space accordingly.

Do not install the sensor on the ceiling or at a location that will not be an accurate representation of the ambient room temperature.

If using a Wireless Mini Sensor Board (WMSB), refer to “**Wireless Mini Sensor Board (WMSB)**” on page 24.

Figure 7 - HMI and Remote Room Sensor

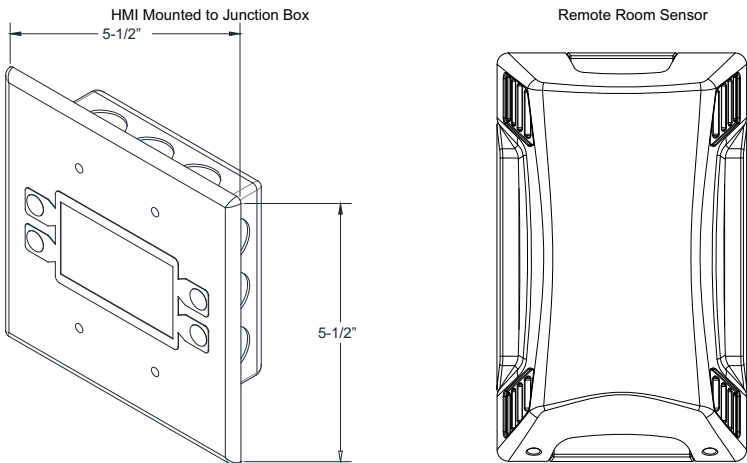

Temperature Sensor

The temperature sensor (**Figure 8**) is a 10K ohm thermistor. The sensor gives constant feedback to the control board. One sensor is installed in every exhaust riser for packages, which include the thermostatically controlled fan option.

There can be a maximum of 32 sensors in the system (including the room temperature sensors). Only a maximum of 8 sensors can be connected to the ECPM03 board, normally one room-temperature sensor and then other temperature sensors. If more temperature sensors are needed, an ECPM03EX board will need to be installed. Each ECPM03EX board can connect up to 8 additional temperature sensors.

Figure 8 - Temperature Sensor



Contactor(s)

A contactor (**Figure 9**) is an electrically controlled switch used for controlling the flow of electricity to an electrical circuit. These can be used to control electric motors, lights, and other electrical loads.

Figure 9 - Contactors

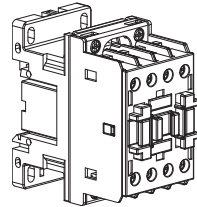

Overloads

Overload relays (**Figure 10**) are devices that are generally connected to a contactor. These relays will actuate a set of contacts if a high current draw is detected on the power flowing through the contactor. They are required for all 3-phase motor applications 2 HP and above. Terminals 97 and 98 provide normally open connections, and 95 and 96 provide normally closed connections. These terminals will activate when the overload circuit is tripped.

Figure 10 - Overload Relay

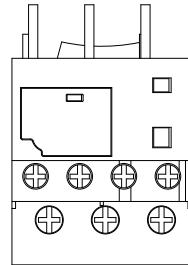

Current Sensor

The current sensor (**Figure 11**) is used to convert the amperage reading from the load to a 4-20mA signal. This signal is used for proving applications of Electronically Controlled Motors (ECM) and contactor controlled motors. Current sensors are only required for non-VFD equipped fans.

Figure 11 - Current Sensor

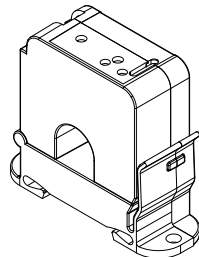

Dry Contacts

Dry contacts (**Figure 12**) are used to provide normally open or normally closed points of wiring when the relay is activated.

Depending on which options are included with the panel, it may be configured with dry contacts that turn ON/OFF with FIRE, ON/OFF with SUPPLY FAN, ON/OFF with EXHAUST FAN. There will be at least two contacts (a single relay) for single zone, or up to four contacts (two relays) for two zones.

Figure 12 - Dry Contacts Wiring Reference

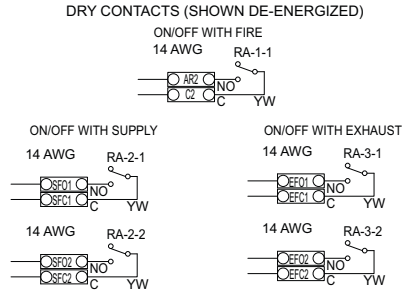

Cooling Panel Fan

If the package is supplied with a VFD, there will be a cooling panel fan (**Figure 13**) mounted in the electrical control enclosure. When the VFD is running, the cooling fan will be activated. The cooling panel fan will be connected to EF1 if there is one zone. If there are two zones, then the fan will run off of a **24V DC** relay driven by RO6. The cooling panel fan will be connected with **120V AC** using the normally open dry contacts.

Figure 13 - Cooling Fan

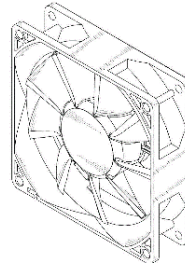

Wireless Mini Sensor Board (WMSB)

The Wireless Mini Sensor Board (**Figure 14**) is used in conjunction with Electrical Control Packages (ECPs). The WMSB is designed to replace room temperature sensors that are installed in areas that are unable to obtain proper room temperature/relative humidity/barometric pressure readings. A significant benefit to using the WMSB is that it is wireless and can be installed in any location in a room to obtain proper connection to ensure the package receives room temperature/relative humidity/barometric pressure readings.

Before installing, find the best location where the sensor can obtain accurate readings for room temperature/relative humidity/barometric pressure. The sensor can communicate overall room temperature/relative humidity/barometric pressure readings to multiple control boards via Bluetooth connectivity.

The photovoltaic solar panel and rechargeable lithium-ion battery located behind the solar panel cover provides continual power and extended battery life to the sensor. The sensor's solar panel must be located in an area where there is bright light, without any impedance to lighting.

Installing the WMSB eliminates the need for a wired thermistor connection back to the ECP. This allows the sensor to be moved and installed anywhere in the space where it can obtain proper room temperature/relative humidity/barometric pressure readings.

NOTE: The battery for the sensor is not connected at the factory. This connection must be completed in the field prior to installing on the wall. Refer to Figure 15 on page 25 for connection locations.

Figure 14 - Wireless Mini Sensor Board

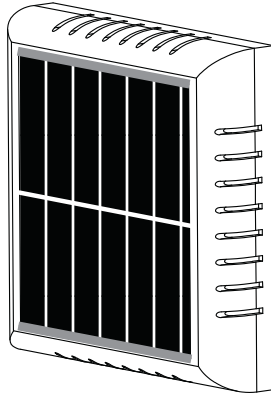

Board Description

Connectors J2 and J3 are the Modbus connections to connect the WMSB to other control boards.

Connector J4 is a 5-pin connector. This connector is divided into two sections. One side of the connector contains analog inputs (24V DC, 0-10V, and a common contact). The other side has temperature input connections (TH, and a common contact).

- 24V DC is the output to power the sensor.
- 0-10V is the input to connect third-party sensors.
- COM is the common (negative) for 24V DC and 0-10V connections.
- TH is the connection for additional thermistor(s) to be connected in the field.
- COM is the common (negative) contact connection.

The P1 (solar cell) connection is located on the backside of the board.

The P2 (battery) connection is located on the front side of the board when installed against a wall. The battery must be connected to the board in the field.

The DIP switches are used to configure the board as a Base or Remote. No pairing is required between the base and the remote units. All configurations are based on the DIP switch settings. Refer to **“Modes of Operation” on page 26** for more information.

- 1111 is used for Base units.
- 0000 through 1110 is used to configure Remote units.

Figure 15 - WMSB Connections

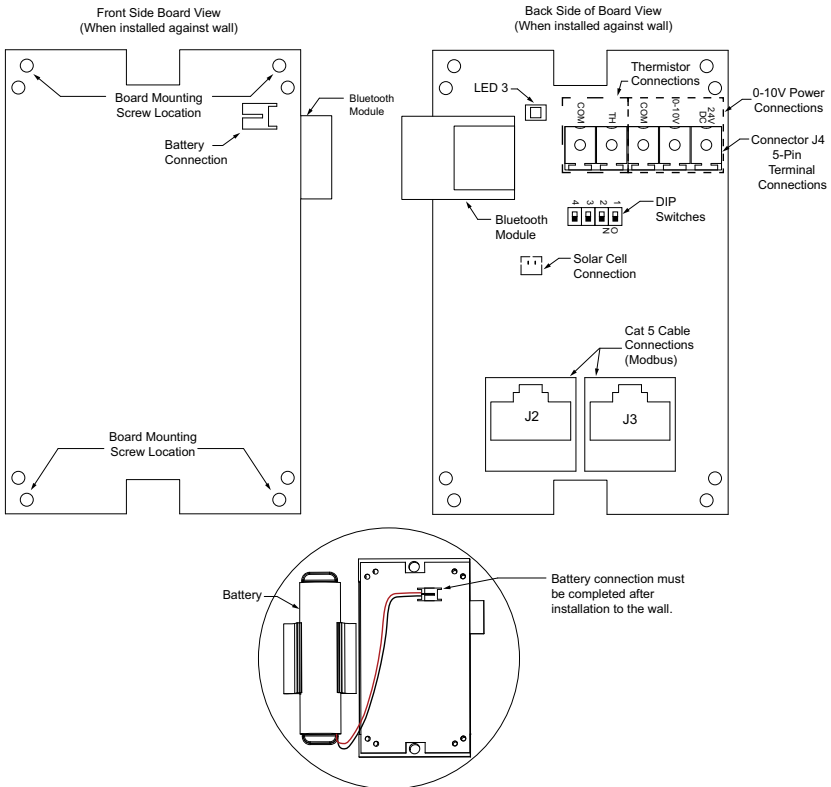

Modes of Operation

There are two modes of operation the WMSB board contains. One is the Base Mode, and the other is the Remote. Each zone can have up to five sensors. For example, DCV packages only use two zones. Therefore, a max of 10 sensors will be used with the system. **DIP Switch Group 1 will be assigned to Zone 1 and DIP Switch Group 2 will be assigned to Zone 2.**

The WMSB Remote will send temperature, relative humidity, and barometric pressure readings to the WMSB Base every transmission rate duration. The WMSB Remote will record a temperature reading every "wake up time" duration. If the temperature reading is 2°F higher or lower than the last temperature reading, it will instantly send the new temperature, relative humidity, and barometric pressure readings to the WMSB Base.

Base Mode - In base operation mode, the WMSB acts as a data collector and communicates to all the remote boards to collect the temperature and relative humidity (RH) readings. The base unit must be powered using 24V DC connections. It can utilize power over a Modbus (Cat 5) connection or hardwired 24V DC power line. The base module sensor should be connected to the Modbus master board using Cat 5.

Remote - In remote operation mode, the WMSB board acts as a data transmitter. It can transmit temperature and relative humidity (RH) information periodically to all base modules.

Figure 16 shows the difference in DIP switch settings. When all the switches are ON (black boxes), the sensor is set to Base. Any combination of switches other than all set to ON, the unit will be configured as Remote.

NOTE: When the rechargeable battery is connected to the sensor, LED 3 will light up for one second. This determines that the WMSB is working and ready to send data via Bluetooth connection.

Figure 16 - DIP Switch Settings

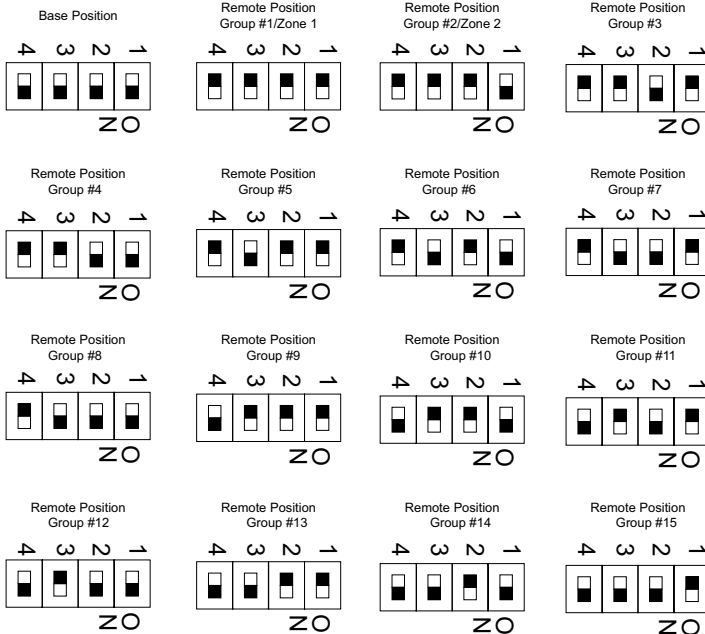

WMSB Installation

Install the sensor in an area where it can obtain accurate room temperature/relative humidity/barometric pressure, and the solar panel will receive sufficient bright light. Keep objects away from the solar panel so as not to impede any light required to keep the sensor's battery charged. Verify the sensor is within 10-15 feet of the electrical control package.

Avoid mounting the sensor in the following locations:

- Where the sensor will be in direct sunlight.
- Near heat emitting from appliances under the hood or warming stations.
- Near diffusers/PSP where the sensor may be influenced by cold or hot air streams.

Best mounting locations for the sensor:

- On a wall near a return duct, if possible.
- A location that will provide an accurate representation of the average room temperature/relative humidity/barometric pressure.

The primary installation options are using provided wall adhesion strips or electrical J-boxes (single or double). Refer to **Figure 19 on page 28** for proper installation examples. Refer to **Figure 20 on page 28** for improper installations.

Wall Installation

When using the provided adhesion strips (**Figure 17**), located on the backside of the sensor base. Clean the wall from any debris, grease, or dirt. Find a suitable location for the sensor, and perform a mock fitment for installation. Remove the top and bottom adhesion strips to install sensor to the wall.

Figure 17 - Adhesion Strip Installation Details

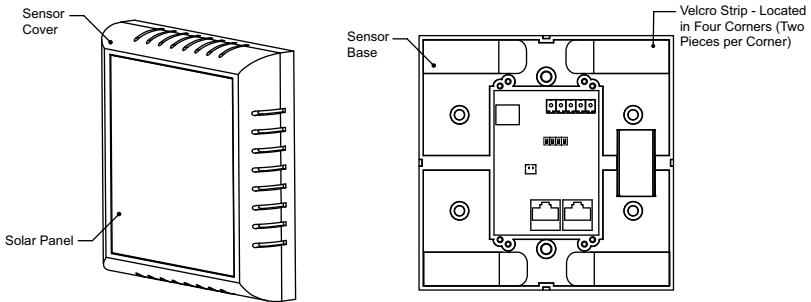

J-Box Installation

When using J-boxes (**Figure 18**) to install into a wall, do not install the WMSB close to high-power (110V AC or higher) wiring or components. Locate the best area for sensor.

Figure 18 - J-Box Installation Details

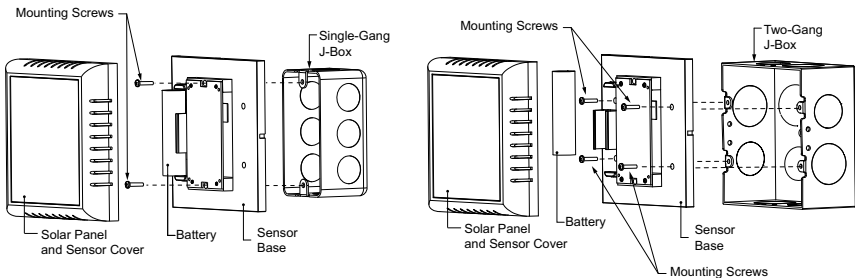

Ambient Lighting Requirements

Lighting conditions for optimum operation of the solar cell is 200 lumens per sq. foot or 20 foot candles.

Figure 19 - Proper Installations

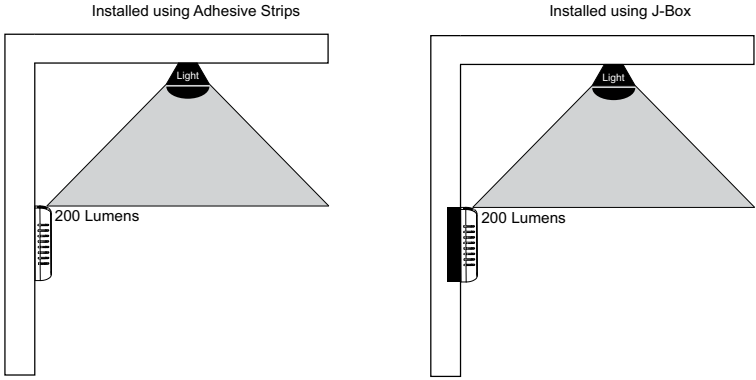
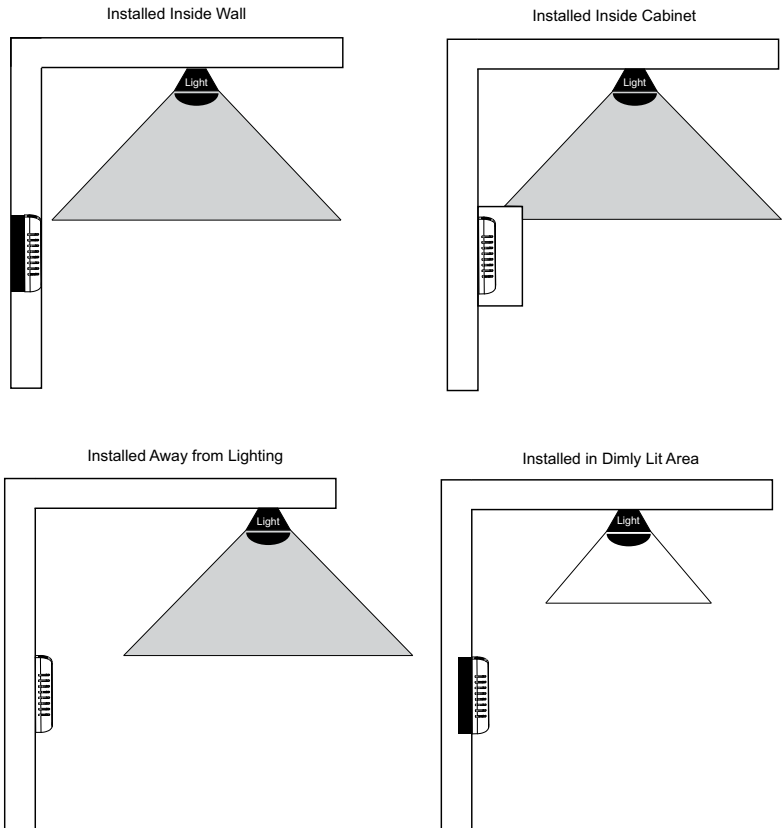

Figure 20 - Improper Installations



DCV Room Temperature Logic

Table 4 - Room Temperature Logic

WMSB	Wired Sensor	HMI Sensor	Average Value
X	X	X	All Sensor Avg.
X	X	-	Two Sensors Avg.
X	-	X	Two Sensors Avg.
-	X	X	Two Sensors Avg.
X	-	-	One Sensor Avg.
-	X	-	One Sensor Avg.
-	-	X	One Sensor Avg.
-	-	-	Preset Room Temp

The DCV will dynamically adjust all the valid readings and ignore the invalid or missing readings. If all reading are invalid, the DCV will revert to Preset Room Temp values.

Electronically Commutated Motor Speed Control

For packages that use the PWM 0-10V Board, see [page 72](#).

External PWM Signal

The ECPM03 board contains four PWM outputs, which can be used to control the speed of an Electrically Commutated Motor (ECM). These PWM outputs are located at connector J10 pins P1A/B, P2A/B, P3A/B, and P4A/B. The PWM signal is a 24V DC output signal that sends a duty cycle pulse. This duty cycle is the percentage of time a digital signal is on during an interval or period of time. This is used to control the speed of the ECM.

Adjusting Job Parameters

The ECM High Speed, ECM Low Speed, ECM CFM can be changed and accessed from the HMI to adjust the operating speed of the ECM. For more information and how to access the parameters, refer to “**Motor Control**” on page 42.

ECM Installation Instructions

It is recommended to use Shielded Twisted Pair (STP) wire for the communication wiring of the signal from the ECPM03 board's PWM signal connection (PxA and PxB) to the input speed control of the ECM. PxA references the positive signal, and PxB references the negative signal. If using a different type of wiring, the wire should be rated for outdoor weather conditions, sunlight resistant, and operate within a temperature range to withstand minimum and maximum ambient temperatures of the job site. If the ECM requires proving, a current sensor is used to monitor the amperage of the motor load. Separate wiring (preferably STP) should be used to run the 4-20 mA signal from the current sensor to the ECPM03 board. Power wiring from the breaker is directly fed to the fan and does not need to run through the Electrical Control Package (ECP). The fan unit will be shipped with power wiring and communication wiring fed to an internal junction box (J-Box). The fan is shipped with STP wire, which is used for wiring to a remote PWM signal. Power the unit off. Remove top cover from the fan. Remove J-Box cover to access wiring connections. Refer to [Figure 21 on page 30](#).

- The STP wire is connected to the communication wiring of the motor using wire nuts in the junction box. If a preset length of STP is provided, it will be connected to wiring located in the junction box from the factory.
- If wiring is not connected from the factory, connect the red wire to the positive PWM signal and the black wire to the negative PWM signal. Reference schematics for all wiring connections (PxA and PxB).
- Run STP wiring through the cooling tube, and along with the power wiring of the fan. Secure the two together with zip ties. Ensure there is enough slack for the fan to hinge open and close freely.

Figure 21 - ECM Fan Wiring

Exhaust Fan Wiring Shown. Supply Fan Wiring Will Vary.
 Remove Top Cover to Access Wiring.

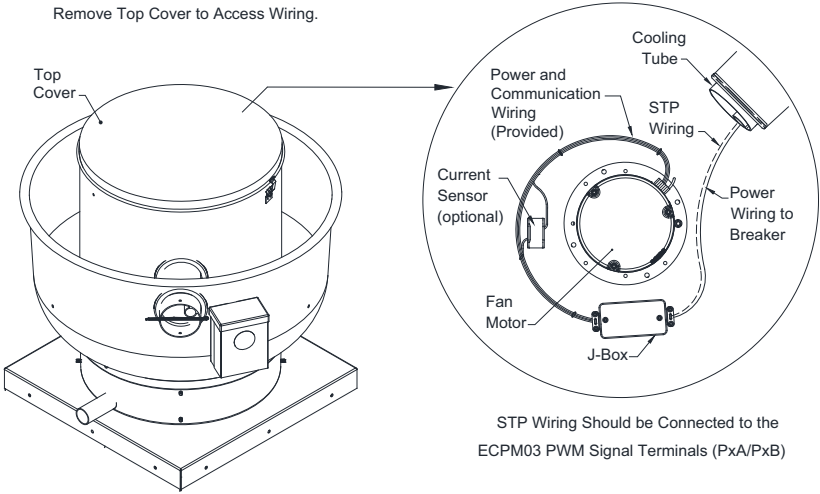

Motor Speed Controller (MSC) Installation

The Motor Speed Controller (MSC) is a versatile device able to output various signal types to many different Electrically Commutated Motors (ECMs). The MSC signal output types can be selected under the 'Motor Type' section of the MSC menu. The MSC may be installed in a fan, remotely in a kitchen space, or in a mechanical room. While this device can be mounted remotely and powered using 24V, it may also be mounted with the fan where it will be exposed to higher voltages. If installed in the fan, the electrical installation must be carried out according to the appropriate regulations (e.g., cable cross-sections, circuit breaker, protective earth [PE] connection). National and local codes must be followed during the installation process.

The MSC board may be powered through a 120VAC/24VAC CLASS 2 transformer, 120V AC/24V DC CLASS 2 power supply, or through MODBUS connections.

The MSC contains static sensitive components. Therefore, you must handle with care to avoid damage to these components. All operations concerning installation, commissioning, and maintenance must be carried out by qualified, skilled personnel who are familiar with the installation, assembly, commissioning, and operation of the electronic board and the application for which it is being used.

Ensure proper handling and avoid excessive mechanical stress. Do not bend any components when handling or installing component. **Do not touch any electronic components or contacts.**

Precautions must be adhered to during installation, testing, servicing, and repairing of this board. Component damage may result if proper procedures are not followed.

Do not install the MSC where it is subjected to adverse environmental conditions such as combustibles, oils, hazardous vapors, corrosive chemicals, excessive dust, moisture, direct sunlight, or extreme temperatures. When removing or installing the MSC to the j-box, verify the gasket is present. All electrical connections for the MSC are located on the backside of the controller. Refer to **Figure 22** for details on installation and electrical connections. When the micro-USB programming port is not in use, place the weather-seal plug into the port location.

NOTE: The MSC can be daisy-chained to VFDs. Each component must have a unique Modbus address for proper operation.

Figure 22 - Installation/Electrical Connections

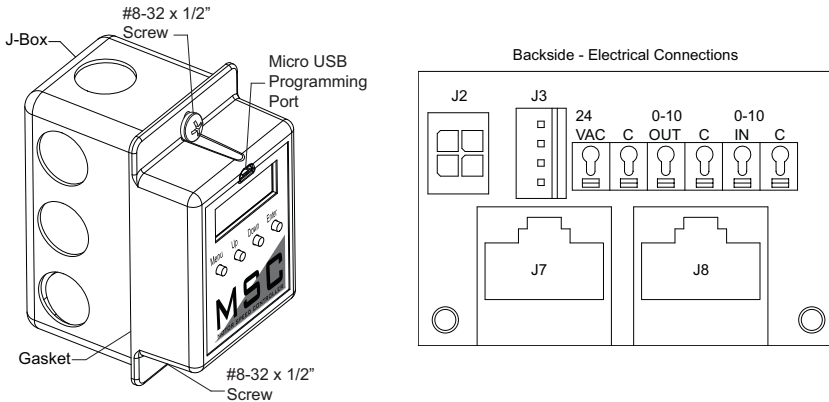

MSC Controller Overview

There are four buttons to navigate through the menu screens, refer to **Figure 23**.

Press the **MENU** button to access menu settings/parameters, pressing **MENU** will also back out of the current menu screen. To scroll through menus, use **UP** and **DOWN** buttons. Press the **ENTER** button to change setting/parameter selection.

To enter password, press MENU, then press **ENTER** when 'Board Config' is displayed. Use **UP** and **DOWN** to scroll through numbers, press **ENTER** to advance to the next numerical setting. To save changes, press **MENU** until the screen displays 'SAVE CHANGES? [ENTER] TO SAVE.' Press the ENTER button to save changes.

Figure 23 - MSC Front Detail View

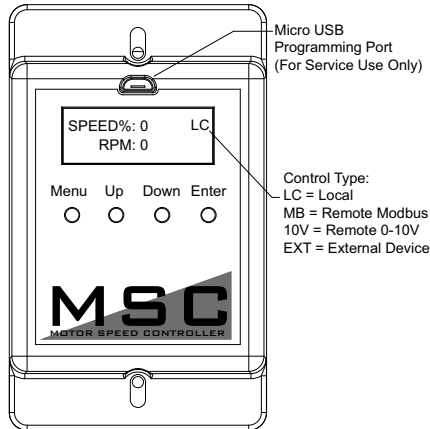

MSC Menu

Board Config - Password (default is 0225)

- **Motor Type** - User may change motor type between Nidec, Telco 42, Telco 48, Ziehl, 0-10V, Other.
- **Control Type** - This setting adjusts how the fan will be controlled.
 - **Local** - The fan will be controlled by the MSC.
 - **Remote Modbus** - The fan will be controlled by another master board through the MSC. A connection between the 0-10V Out to 0-10V In must be made for start command.
 - **Remote 0-10V** - The fan will be controlled by an external 0-10V signal.
- **Speed Settings** - Provides access to speed and voltage settings.
 - **Low Speed** - Adjustable speed from 20% up to high speed setting, or 0-10V. Setting cannot go above High Speed parameter.
 - **High Speed** - Adjustable speed from 100% down to low speed setting, or 0-10V. Setting cannot go below Low Speed parameter.
 - **Set Speed%** - Adjustable speed range is dependent on Low Speed and High Speed settings. This controls the output of the motor.
 - **Voltage Range** - Only available when Motor Type 'OTHER' is selected. Default setting is 24V. Other available voltages are 5V and 10V.
- **Modbus #** - Adjustable Modbus ID. Exhaust Fan range 11 through 18, Supply Fan range 21 or 22. **A VFD and MSC cannot use the same Modbus #.**
- **Options**
 - **Feedback Fault** - If set to ENABLED, the MSC will monitor RPM feedback. If the MSC does not receive data for 30 seconds or 70% of the expected RPM, this fault will be displayed. **Ziehl motors do not provide feedback.**
 - **2 Speed** - The 0-10V output cannot be used when the 2 Speed or Manual Speed options are On, or if the 'Control Type' is set to Modbus. When the 0-10V OUT and 0-10V IN terminals are **not** jumped together, the fan will operate at low speed. When 0-10V OUT and 0-10V IN terminals are jumped together, the fan will operate at high speed.
 - **Analog Speed** - The user may enable/disable the option, and calibrate a potentiometer for proper operation that is connected between the 0-10V OUT and 0-10V IN terminals. When enabled, you must calibrate the potentiometer. Follow the MSC's on-screen instructions. The speed will be adjustable between 0V (low speed) to 10V (high speed).
 - **Input Threshold** - When control type is set to Remote 0-10V, an input threshold will be created for motor control. Refer to **Figure 24 on page 35** for threshold examples.
 - **Zero Operation** - The user may select how the motor will operate when the 0-10V input is at 0V. The options will be Off or Low Speed (default).
 - **Threshold** - Increasing the threshold value will allow for the device to hold its voltage/RPM output while the input is between the 0 - threshold value.
- **Restore Settings** - Provides access to restore factory settings, and test & balance settings.
 - **Factory Settings** - This will reset all values back to factory settings.
 - **T & B Settings** - This will reset all values back to last saved test & balance settings.
- **Change Password** - Users may update the password setting to their own preference. Password 0225 will also be stored for backup. Both passwords will allow users to enter 'Board Config' settings.

Software Version - Displays the current software version installed on the board.

Faults - This provides access to 'Fault History,' 'Fault Totals,' and 'Clear Faults.'

- **Fault History** - Displays fault history and board reboots in chronological order. Possible displayed faults are:

- **No Faults** - There are no active faults with the system.
- **Feedback Fault** - Only displayed for motors with feedback capabilities.
- **Reboot** - Any time the fan goes from OFF to ON, this "fault" will be logged. This fault will only display in 'Fault History.'
- **Modbus** - Issue with Modbus communication between the MSC and master board.
- **Variable Device Fault** - When 'Analog Speed' is selected and a potentiometer is connected, if the voltage drops below 1V, this fault will be displayed.

- **Fault Totals** - Displays the number of faults for Modbus, Feedback, Var Device, Reboot, and Total Faults.

- **Clear Faults** - Users may clear all faults from the board.

Service - This provides access to service settings. Password: 1234

- **Save T & B** - After the test & balance process has been completed, save adjustments under this menu.
- **IO Status** - Provides access to information about the inputs and outputs of the MSC board.
 - **V In** - Displays the incoming voltage (0-10V) to the MSC.
 - **V Out** - Displays the output voltage (0-10V) to the motor.
 - **RPM** - Displays motor RPM feedback. **Ziehl motors do not provide feedback.**
 - **PWM V** - Displays equivalent voltage reading of the PWM output to the motor.
 - **Speed%** - Displays PWM percentage output value to the motor.
- **Modbus Status** - Provides access to expected and actual speeds in hertz and percentage.

Input Threshold

Figure 24 - Input Threshold Examples

Factory Default: Zero operation set to low speed, threshold set to 0V.

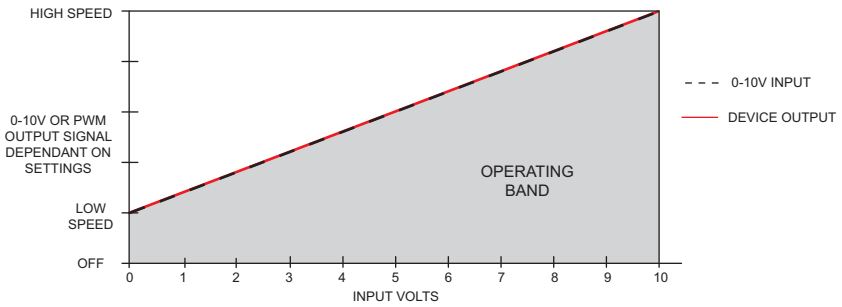

Zero operation set to low speed, threshold set to 2V.

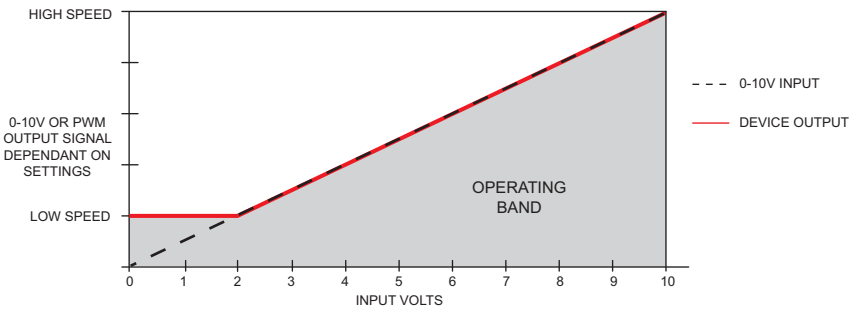

Zero operation set to off, threshold set to 2V.

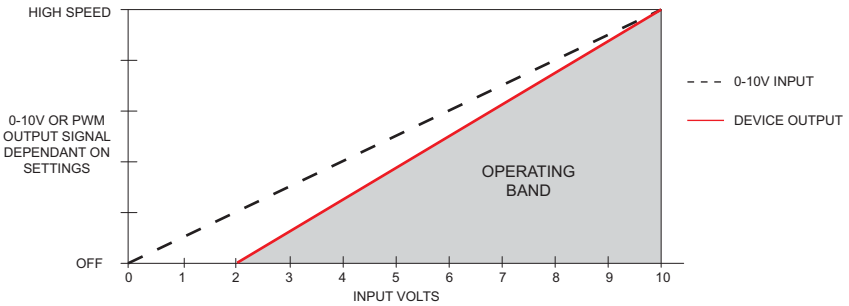

MSC Menu Tree

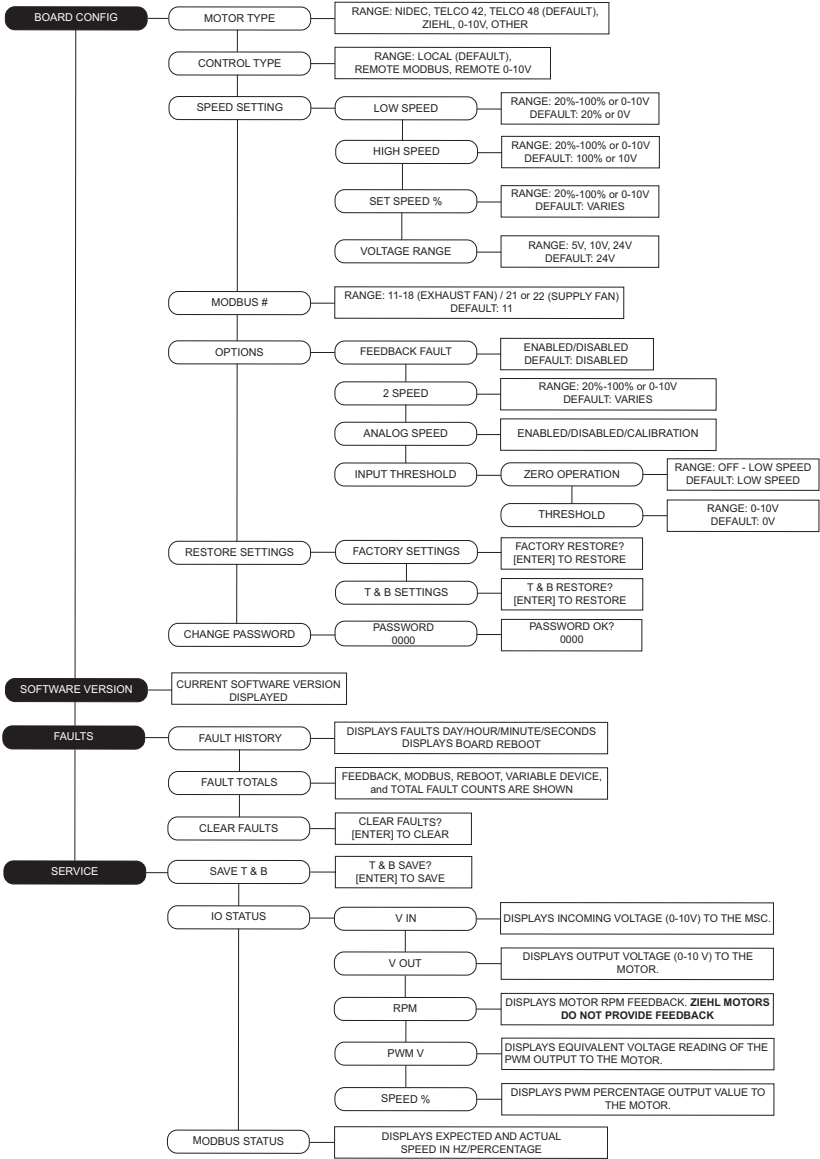

OPERATION

HMI Function

NOTE: The fire system must be in an ARMED state before proceeding (C1 terminal block must have continuity with AR1 terminal block).

Once all required connections have been completed as indicated on the installation schematic, start-up can begin. Apply power to the panel and fans. The ECPM03 board and the HMI(s) will power up. If the unit does not power up correctly, check all power connections. Verify no alarm message(s) are displayed on any of the HMI screens. If there are alarms present, you can press the MUTE button to silence the alarm and then work to resolve them.

Figure 25 - HMI Buttons

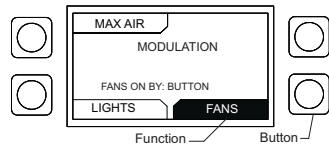

The HMI has 4 buttons (**Figure 25**); a function is displayed adjacent to each button on the LCD. These functions will change depending on the status of the panel. If no text is adjacent to the button, it does not have a function.

Typically, the bottom two buttons are for operating the LIGHTS and FANS functions. The status of those elements is shown by the shading used inside the box associated with the function. An unshaded box around the FAN function means that the fans are turned off. A dark box around the FAN function means that the fans are turned on. The same applies to lights.

NOTE: For the rest of the document, the term button will be used to refer to either the actual button or the function associated with it.

The HMI will display informational or fault messages in the main body of the screen.

When a fault occurs, an audible alarm is triggered and a message is displayed on the HMI(s). The audible alarm can be silenced by pushing the MUTE button that appears on the top right corner.

Press the LIGHTS button to energize the hood lights. If the lights do not come on, make sure the light bulbs are installed and/or check the lighting circuit. To dim the lights, press and hold the LIGHTS button for 3 seconds. **See “Light Brightness” on page 72.**

Press the FANS button to energize the fans. When dynamic mode and prep mode are enabled, pressing the PREP OFF button will turn prep mode off and put the system into modulation mode. **See “Dynamic Fan Zone” on page 61.**

If cooking appliances are connected to an electric gas valve, then the electric gas valve is controlled by the control package. The GAS/GAS RESET button will only show if the “Gas Valve Option” is set to YES. The gas valve can be turned on by pressing the GAS RESET button on the top right corner of the HMI. If the control package includes the CORE Appliance Fire System, Onboard Wash, or Electric Wet Chemical with Self-Cleaning a WASH button will be displayed on the HMI. Push the button to start the wash cycle. Water will be sprayed in the plenum and duct of the hood, and surfactant will be injected every minute during the wash. The wash cycle will stop when the wash timer expires or when the STOP WASH button is pressed. **Make sure the hood filters remain in place during the wash cycle.**

If the “Proving” option is enabled, a calibration step is required at initial start-up. Refer to **“Proving Enabled (Optional)”** on page 58 for further details about this function. The calibration process is also available through the control board, refer to **page 19.**

HMI Configuration

Configuring settings are done through the HMI by pressing the top two buttons on the HMI.

To set the HMI number or to adjust the screen contrast, press the bottom two buttons simultaneously on the HMI faceplate. Use the Up and Down buttons to select the parameter that will be adjusted. Press Enter to select the highlighted parameter.

Setting the HMI number configures the Modbus address for that HMI.

To change the contrast, select “Advanced Options.” The user may adjust the setting from 0 to 10. Setting the contrast to 0 is the lowest setting available and 10 is the highest contrast setting available. The factory default contrast setting is 5.

To set the clock, refer to “**Set Clock**” on page 39.

To view, set, or adjust board options, refer to “**Board Settings**” on page 40.

To monitor diagnostic values, refer to “**Diagnostics**” on page 73.

Passwords

To access the Configuration for Factory Options, the password 1111 must be used.

To access the Configuration for Motor Control, the password 1111 must be used.

To access the Configuration for Fire Options, the password 1234 must be used.

After changing parameters in the configuration menus, the user needs to press MENU multiple times on the HMI until the screen displays “SAVE CHANGES?” (Figure 26). The screen will display:

- DISCARD – Pressing the **DISCARD** button will erase any parameter changes made in the HMI during this time. This will not erase parameter changes made previously.
- CANCEL – Pressing **CANCEL** will take you back to the options settings. This will not discard any parameter changes made.
- SAVE – Pressing **SAVE**, the screen will display “Saving...Wait for reboot”. As indicated, the processor will reboot. This allows the board to correctly process the parameters changed.

All the items below are accessed by putting the **HMI into Configuration mode**.

Figure 26 - Save Changes

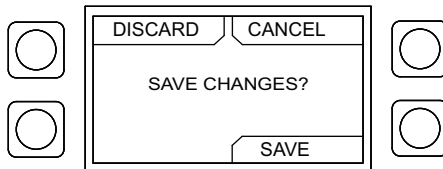

Set Clock

To set the clock (**Figure 27**) on the HMI, enter the HMI configuration mode. Scroll to "SET CLOCK," press **ENTER**. When configuring the time setting, use the **ENTER** and **MENU** buttons to cycle through the parameters. Use the **UP** and **DOWN** buttons to set the parameter. Once the parameter is set, press **ENTER**. After all of the settings are set, press the **MENU** button continuously to back out and save settings.

Figure 27 - Set Clock

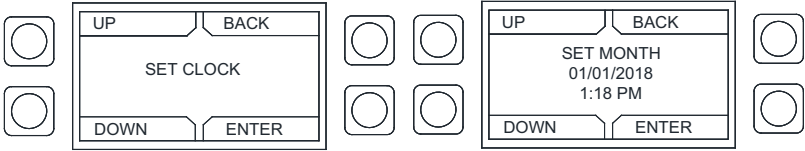

ESP Dry Mode

Following an ESP self-cleaning cycle, the PCUAFM board will force the fans on for the duration of the ESP dry mode timer (**Figure 28**). The time will be displayed on the DCV home screen. The wash button will be hidden while the dry mode timer is active.

Figure 28 - Dry Mode Timer

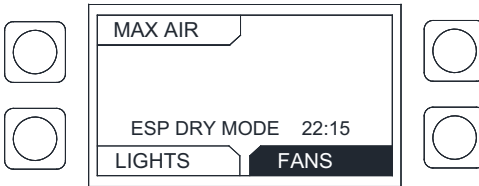

Board Settings

Options

Allows the user to set preferences for the system. **Setting defaults will vary depending on how the package was ordered from the factory.**

- Language (Factory default is English) – The user may set the language between English or Spanish.
- Temperature Units (Factory default is Fahrenheit) – The user may set temperature units to Fahrenheit or Celsius.
- HMI Dimming? – This option allows the backlight on all HMIs to turn off whenever a timer is satisfied. The timer is refreshed every time HMI button is pressed.
- HMI Dim Delay – Available if HMI dimming is set to On. Allows user to set dimming time preference for HMI.
- Is Sequential Wash Enabled? – Available if CORE is enabled. Wash each individual CORE system with sequential delay.
- Sequential Wash Delay – Available if CORE is enabled. Allows user to set a time delay between wash cycles.
- Sequential Wash Both Zones – Available if CORE is enabled. The wash cycle will wash each zone one at a time.
- Fan Status Relay 4 / Fan Status Relay 5 – Zone 2 offers the same status selections as Zone 1. When one of the status options is selected, the relay will output a signal to the fan status light.
 - RO Disabled
 - Zone 1 Proving Fault
 - Zone 1 Proving Calib
 - Zone 1 System Bypass
 - Zone 1 Max Air
 - Zone 1 Wash
 - Zone 1 Temperature
 - Zone 1 Occupied
 - Zone 1 BMS Fans
 - Zone 1 IO
 - Zone 1 Fans Button
 - Zone 1 BMS Prep
 - Zone 1 Prep Button
 - Zone 1 Prep Temp
 - Zone 1 HRC Defrost
 - Zone 2 (Same selections as Zone 1)
 - Zone 1 Any
 - Zone 2 Any
 - Zone 1 and 2 Any
 - Zone 1 Any Prep
 - Zone 2 Any Prep
 - Zone 1 and 2 Any Non Prep
- Scheduling? – Allows the user to set scheduling to be active.
- Occupied Fans On – Allows the user to set the fan zone to activate during the occupied time setting.
- Unoccupied Offset 1/2 – This allows the user to add an unoccupied offset temperature range (0-30°F) on top of the other system offset settings. Use this setting to prevent false fan activation during an unoccupied time range.

Options – Board Restart

Changing the following settings will cause the board to restart:

- Enable/Disable CORE Wash
- Enable/Disable PCU CORE Wash
- Enable/Disable Core Ansul Recovery Coil
- On-board Wash
- Sequential CORE Wash
- Is Proving Enable
- Canadian Proving Enable
- Fans Continue in Proving
- CS Assignment
- CS Proving %
- Celsius/Fahrenheit
- Lights During Fire
- Supply During Fire
- Gas Valve Enable
- Kill Switch Enable
- Gas Follow Fans
- Shunt Follow Fans
- Dim Enable
- Auxiliary Interlock
- Low Surfactant Shut-down
- Supply Share – Static Speeds
- Supply Share – Dynamic
- Number Of Light Zones
- Wash Speed % Of Fan High Speed
- Fan Direction
- Dim Delay
- Fan Zone Assignments
- Number Of Temp Sensors
- Number Of HMIs
- Number Of Fan Zones
- VDC Output Type
- Number Of PCUAFM
- Number Of EXH VFDs
- Number Of SUP VFDs
- Number Of EXH ECMs
- Number Of SUP ECMs
- VDC Output Range
- Language
- Exhaust During Fire
- Current Sensor Proving %
- Fan CFMs
- Min Prep Frequency/Speed
- Fan Controller Type
- VFD Proving %
- IO Delay
- Fan Zone – Static/Dynamic
- Constant Transfer CFM
- Prep Enabled
- IO High Speed?
- Independent Light Control?
- Cool Timer
- HMI Fan Zone Assignment
- HMI Enable Light Switch
- HMI Enable Fan Switch

Changing the following options will not cause the board to restart:

- Prep Offsets
- Temp Sensor Offsets
- Temp Sensor Assignments
- Fan Modulation
- Min Room Temp
- Preset Room Temp
- Hysteresis Temperature
- Hysteresis Time
- Manual To Auto Fans Time
- Max Air Time
- Wash Time
- Autowash Min Fan Runtime
- Autowash Min Interval Time
- Fan Status Relays
- CORE Zone Assignments
- Unoccupied Offset 1/2
- Sequential Wash Delay
- Number Of Light Zones
- Time Zone ID
- Hood Recovery Coil Temp
- All Zones On During Wash
- Fan Low Frequency/Speed
- Fan High Frequency/Speed
- Occupied Fans On 1/2

Motor Control

Motor Control is visible when a fan is controlled by a VFD or ECM. The motor control menu allows the user to access the control settings for the motor. The selectable motors are dependent on the number of Exhaust VFDs, Supply VFDs, Exhaust ECMs, and Supply ECMs. Verify if the fan zone is set to static or dynamic, check “Fan Zone Config” setting located in “**Factory Options**” on page 53.

If the fan motor unit is assigned to a dynamic zone, see “**Motor Control - Fan Zone set to Dynamic**” on page 51. If the fan motor unit is assigned to a static zone, see “**Motor Control - Fan Zone set to Static**” on page 52. Certain parameters may need to be adjusted in the field if there is an existing motor on the job site, see below parameters marked with an (*).

EXH VFD

- Min Prep Frequency (prep enabled)
- High Frequency*
- Low Frequency*
- CFM*
- Modulation
- Direction (Rotation of motor)

SUP VFD

- High Frequency*
- CFM*
- Direction (Rotation of motor)

EXH ECM

- Min Prep Speed (prep enabled)
- High Speed*
- Low Speed*
- CFM*
- Modulation

SUP ECM

- High Speed*
- CFM*

VDC Output Type

- Light Control
- Zone 1 Supply
 - High Speed*
 - CFM*
- Zone 1 Exhaust
 - Min Prep Speed (prep enabled)
 - High Speed*
 - Low Speed*
 - CFM*
 - Modulation
- Tot XFR (Total Transfer) Ratio Zone 1
- Sup (Supply) CFM Ratio Zone 1
- Exh (Exhaust) CFM Ratio Zone 1
- None

Min Prep Frequency (Factory Default: 15Hz) – This option is only visible when Prep Time Mode is enabled. Its maximum value is the minimum of the low frequencies of all the fans controlled by the package, and the minimum value is 10Hz.

Factory Options

This sub-menu is Password protected (1111).

Fan Zones (1 or 2) – This function allows the user to set the number of fan zones in the system. This can be configured to 1 or 2 fan zones. Certain features will restrict the number of fan zone selections. The **On-board Wash** feature will restrict the system to 1 fan zone. The **Supply Share Static** and **Dynamic** will restrict the system to 2 fan zones.

Fan Zone Config – This allows the user to set various configurations in the fan zone.

- **Is Dynamic?** – Yes/No option. When the zone is set to dynamic and the motor is on a VFD/PWM, it will modulate based on temperature. When the zone is set to static (Is Dynamic? set to no), the VFD/PWM will only operate at one speed on activation.
- **Is Prep Enabled?** - Option is visible when the zone is dynamic. Yes/No option.
 - Preparation mode is available for morning operation when appliances are off or when very light food preparation is performed. Dedicated make-up air will be locked out, only allowing the use of transfer air during this mode.
 - The speed of the exhaust fan(s) in Preparation Time is calculated automatically and is equal to the speed that will produce the same amount of CFM than the Transfer CFM when the fans are running at full speed in normal operation. If there is no dedicated supply fan in the system, the exhaust fans will run at the set high frequency divided by 4 (typically 15 Hz).

NOTE: If the calculated value falls below the set minimum frequency, then the value will be adjusted to the lowest allowable frequency.

- **Constant Transfer CFM?** – Yes/No option. This feature alters the calculation for supply frequency for a dynamic zone. The difference between exhaust and supply ratio will be held constant.
- **Independent Light Control?** – Yes/No option. The independent light control feature allows the user to control the lights from the HMI. If independent light control is disabled, the lights will automatically activate whenever the fans activate.
- **IO Delay** – This option is intended for applications that require the fans to keep running for a specific amount of time after an external signal (BMS, machine, etc.) is turned off. The delay time value may be set up to 18 hours. The fans will remain on for the set time after the external signal is de-energized.
- **Preset Room Temp** – 75.0°F (default). Allows the user to adjust Preset Room Temperature.
- **Minimum Room Temperature** – 50.0°F (default). This prevents a system from activating the fans unnecessarily due to a large gap between room temperature and the thermostatic temperature sensors. This option can also help alleviate fan activation troubles with lower temperature appliances, which are not satisfying the minimum temperature requirements for fan activation.
- **Maximum Room Temperature** – 120.0°F (default). When the room temperature sensor reading is above the maximum room temperature setpoint, the system will use the maximum room temperature setpoint overriding the room temperature reading. This will prevent poor operation when a room temperature sensor receives a false high temperature reading that is not a true representation of the space room temperature.
- **Temp Hysteresis** – 2.0°F (default). The hysteresis is used to prevent the fans from cycling on and off when the temperature in the tempering space is near the activation value. The fans will turn on when the duct temperature exceeds the activation value, but they will only turn off when the duct temperature goes below the activation temperature minus the temperature hysteresis. For example, if the Activation

Temperature is at 85°F and Temperature Hysteresis is set to 2°F, the fans will turn on at 85°F and will turn off at 83°F.

- **Hysteresis Timer** – 00:30:00 (30 minutes default). The hysteresis is used to prevent the fans from cycling on and off too often due to small appliances generating just enough heat to turn on the fans but not enough to keep them on for a long time. The hysteresis timer will maintain the fans on after they have been activated by temperature for a minimum time set by this timer, even if the temperature in the duct cools back down.
- **Is Max Air Enabled?** – Option is visible when the zone is dynamic. Yes/No option. If Max Air is enabled, a **MAX AIR** Button will appear when the system is in modulation mode. If pressed, this will send the system into Maximum Air Mode.
- **Max Air Time** – Option is visible when the zone is dynamic. Max Air Timer maintains all exhaust and supply fans running at their maximum frequency for the configured time.
- **Manual to Auto?** – Yes/No option. When the system is turned on manually (by button) a timer will start that sends the system into automatic mode once the timer is completed (this is advised to be about the length of time the restaurant will be open).
- **Exhaust Contactor CFM/Supply Contactor CFM** – Option is visible when zone is dynamic. The user can adjust the CFM from 0-65,000 CFM.
- **Cool Time** – Option is visible when zone is dynamic. The fans will go into cool down mode when the duct temperature goes below the activation point minus the temperature hysteresis of 2 degrees. For example, if the activation temperature is at 85°F and the hysteresis is set to 2°F, cool down mode will start at 83°F.
- **IO High Speed Mode?** – Option is visible when zone is dynamic. Yes/No option. Enters high speed once **120V AC** is detected on IO input. The fans stay on for as long as the IO High Speed Timer is set. The 120V AC must be sourced from the same breaker as the control power, terminal H1.
- **Wash time** – 03:00 minutes (default).
- **Autowash Min Fan Runtime (H)** – This is the minimum amount of time the fans must be running for autowash to occur.
- **Autowash Min Interval Time (H)** – Adjustable between 0-24 hours. This is the minimum amount of time between washes for autowash to occur.
- **Wash Speed % Of Fan High Speed** – This percentage is used to calculate the fan speed of VFD or PWM controlled exhaust. The actual wash speed of each fan is determined by multiplying the wash speed percentage by the high frequency of the exhaust fan.
- **WMSB Temp Averaging Enabled?** – Yes/No option. When set to Yes, DCV includes all WMSB temp readings to be averaged into the room temp readings.

Light Zones (0-2) – This allows the user to set the number of light zones. This feature allows for the light zones to be independent of the number of fan zones. RO1 is used to activate a 24V DC relay to control light zone 1. RO2 is used to activate a 24V DC relay to control light zone 2.

HMIS (1-4) – This allows the user to set the number of HMI(s) in the system. Each package should have at least one HMI in the system to easily access features. The system can operate without an HMI connected.

HMI Config – This allows the user to select:

- Zone Assignment – Assign the HMI to a fan zone.
- Enable Light Switch – Yes/No option.
- Enable Fan Switch – Yes/No option.
- Enable Temperature Sensor (internal to HMI). Yes/No option.

Temp Sensors – This menu is where the number of temperature sensors in the system can be set. Only a maximum of 8 sensors can be connected to the ECPM03 board. If more sensors are needed for the system, you will need to add the ECPM03EX board. Up to 32 sensors can be added to the system.

Temp Sensor Config – This allows the user to set various configurations for the temperature sensors. See **“Temperature Selection and Configuration” on page 48** for more information.

Exhaust VFD (0-8) – This menu is where the number of exhaust VFDs controlled by the ECPM03 board can be set. VFDs are connected from the J3 port on the ECPM03 using Cat 5 cable. Successive VFDs are daisy-chained. The Modbus address for exhaust VFDs starts at 11 and ends at 18. The first VFD in the chain is defined as Modbus address 11. The second VFD is assigned to Modbus address 12, and so on.

Supply VFD (0-2) – This menu is where the number of supply VFDs controlled by the ECPM03 board can be set. VFDs are connected from the J3 port on the ECPM03 using Cat 5 cable. Successive VFDs are daisy-chained. The Modbus address for exhaust VFDs starts at 21 and ends at 22. The first VFD in the chain is defined as Modbus address 21. The second VFD is assigned to Modbus address 22.

Exhaust ECM (0-4) – This menu is where the number of exhaust ECMs in the system can be set. The PWM wiring is connected to PWM signals on the board at connector J10 pins P1A/B, P2A/B, P3A/B, and P4A/B. Only 4 ECMs may be assigned between the exhaust and supply. PxA is the positive PWM signal and PxB is the negative PWM signal.

Supply ECM (0-4) – This menu is where the number of supply ECMs in the system controlled by the ECPM03 board can be set. The PWM wiring is connected to PWM signals on the board at connector J10 pins P1A/B, P2A/B, P3A/B, and P4A/B. Only 4 ECMs may be assigned between the exhaust and supply. PxA is the positive PWM signal and PxB is the negative PWM signal.

Is Proving Enabled? – The supply fan and exhaust fan activate simultaneously.

Is Canadian Proving Enabled? – The supply fan must prove first, then the exhaust fan.

Fans Continue In Proving Fault? – The fans will continue to operate if a proving fault is active.

NOTE: When proving options are enabled, the user may configure the minimum setpoint that the motors are considered to be proven. These values can be changed at CS1 Proving percentage through CS5 Proving percentage for any current sensor. The VFDs setpoint can be set under motor control. See **“Menu Tree” on page 50**. Verify with local/regional codes for proper settings. Refer to **“Proving Enabled (Optional)” on page 58** for more information.

Select Current Sensor – Allows user to assign a current sensor to a fan. While the fan is operating, amperage draw is monitored to validate proving.

- **CS Assignment** – Assignable current sensor options.
- **CS Proving %** – Minimum percentage setpoint for proving.

PCU AFM – Defines the number of PCU AFM boards that communicate back to ECPM03. This allows for the DCV system to display any PCU AFM errors on the HMI.

Is On-board Wash Enabled? – Yes/No option. If this feature is enabled, the system will only be allowed to operate with one fan zone configuration. This enables connector J8 on the electrical board to be used for wash control. Connector J8 is a five-pin connection. Pin EF2 is used to control the hot water solenoid. Pin SF2 is used to control the surfactant pump. Pin OV2 is used to monitor the liquid level sensor. Pin IO2 is used to prime the pump system.

Surfactant Duration – Allows the user to increase time setting for surfactant injection duration. For heavy-duty grease applications, increase the injection duration during wash cycles. Adjustable range from 1-15 seconds.

Disable Autowash – Allows the user to disable the autowash function. This function should be disabled if wash is controlled through a schedule. If no schedule is defined, autowash timers will need to be enabled.

VDC Output Type – The demand control system provides a 0-10V DC analog output from VO- and VO+ directly proportional to the calculated ratio for fan speed and light dimming control. This output can be configured depending on the type of signal needed by the building management system or the equipment receiving it.

The types of signals that are available:

- Light Brightness = Voltage signal
 - Total Exhaust CFM Ratio = Total Operating Exh CFM / Total Design Exh CFM
 - Total Supply CFM Ratio = Total Operating Sup CFM / Total Design Sup CFM
 - Total Transfer CFM Ratio = Total Operating Transfer CFM / Total Design Transfer CFM
 - Zone 1 or Zone 2 Exhaust
 - Zone 1 or Zone 2 Supply
- Total Exhaust CFM Ratio could be sent to a Roof Top Unit providing make-up air to the hood.
 - Total Transfer CFM Ratio could be sent to an HVAC unit indicating how much transfer air is needed for the kitchen. This selection takes into consideration the Preparation Time Mode, where the same amount of transfer air is used when the fans are all running at maximum speed.
 - Total Supply CFM Ratio is only available if a supply fan is present in the DCV system. In Preparation Time, Total Supply CFM Ratio would be 0.

VDC Output Range – VDC output signal options are **0-10V DC** or **2-10V DC**. Provides a linear representation of exhaust or supply motor speed.

Supply Share Static – Yes/No option. IL1A and IL1B must be jumped with a proving damper signal for the supply fan to run. Setting up a 2 zone configuration: Consists of 1 supply fan and at least two exhaust fans. When supply share static is on, there will be three Zone Supply % options available. The exhaust fans will run at the single speed defined by job requirements.

- If the zone 1 fan is turned on, then the exhaust fan will turn on, and the supply fan goes to speed one (**Supply % EF1**).
- If zone two is on, then exhaust fan Zone 2 will turn on, and the supply fan speed goes to speed 2 (**Supply % EF2**).
- If both zone 1 and zone 2 are on, then the supply fan will go to speed 3, (**Supply % EF1 and EF2**).

Supply % EF1 – This is the supply speed when Zone 1 is on. EF1 Only > 50% (typical).

Supply % EF2 – Supply speed when Zone 2 is on. EF2 Only > 50% (typical).

Supply % EF1 and EF2 – Supply speed when both zones are on. This option is ideal for using one supply fan to provide makeup air to a building. The supply fan will run at the set speed based on which zone is currently on. EF1 and EF2 > 100% (typical).

Supply Share Dynamic – Yes/No option. This option is an adaptation of supply share static where the fans will automatically calculate the starting speed based on the fan CFM. The supply will appropriately compensate for the speed of either or both exhausts.

Modbus – This menu will allow you to view the Modbus address of the ECPM03 board. This address should always be set to 59. Do not change this address.

Low Surfactant Shut-Down – Yes/No option. This allows the user to have the system shutdown when the surfactant level is low with a CORE system. When the level is low and activates the shut-down process, the gas output signal will be de-energized and the kill switch will be de-energized. The shunt trip will be energized.

Hood Recovery Coil Enable? – Yes/No option. Allows the user to enable the Hood Recovery Coil (HRC) option, if applicable. When the appliances are not in use and this option is enabled, the hood recovery coil temperature setting is used to operate the exhaust fans. The exhaust fans will remove cold air preventing damage to the hood recovery coil system.

Hood Recovery Coil Temp – 40.0°F (default). This is an adjustable setting that allows the user to set the HRC temperature setpoint. The hood input coil and hood output coil temperature sensor monitors the temperature in the duct and plenum. When the temperature drops below the setpoint, the exhaust fans will turn on and remove cold air from the duct and plenum. The hood input and output coils may not be located by the HRC. Since these temperatures are used as reference points, you may want to set the temperature threshold higher as the temperature may be colder near the HRC.

Residential Hood Option – Yes/No option. Allows the user to enable the residential hood option, if applicable. Refer to Light Commercial Hood Manual for more information.

Residential Hood Fire Set Point – When the hood thermistor exceeds setpoint (default 150°F), the hood will enter a FIRE state. Once the temperature drops below setpoint, press “Reset” on the HMI. User may adjust setpoint between 150 to 200°F.

NFPA 101 Compliant – NFPA requires that a fire system covers a residential hood. If the hood is set to No, the residential hood will not be compliant.

Residential Fire System – Set the type of fire system installed on the hood.

Residential Max Air Mode – On/Off option. When the hood is in static mode and max air is On, the “Max Air” button is displayed. When pressed, the fan speed will go to high speed for the duration of max air timer. High speed is set under “Motor Control/Exh ECM.” “Max Air Time” is set under “Fan one Config.”

Residential Fan Polarity – Enables the ability to inverse the PWM output from the board to the residential hood fan. Set at the factory based on fan model.

WMSB Enabled? – Yes/No option. Enable this option when the Wireless Mini Sensor Board (WMSB) will be utilized to monitor temperature/relative humidity readings.

Factory Reset – This will allow the system to be restored to original factory settings.

Temperature Selection and Configuration

Monitoring Sensors

- Room Temp
- Preset Temp
- Auxiliary Temp
- PSP Discharge
- ACPSP Discharge
- Contact Monitoring
- Water Temp

Control Sensors

- Contactor Zone 1 Riser
- Contactor Zone 1 Capture Volume
- Contactor Zone 2 Riser
- Contactor Zone 2 Capture Volume
- VFD Riser Exhaust
- VFD Capture Volume Exhaust

Control Sensors

- ECM Riser Exhaust
- ECM Capture Vol Exhaust
- VDC Output Riser Exhaust
- VDC Output Capture Volume Exhaust
- Hood Coil Input
- Hood Coil Output

Each fan zone must have a room temperature setting which is used for temperature offset calculations. The ECPM03 board can average HMI temperature sensors, along with other room tempering sensors that are assigned to a zone.

- Room Temperature – A temperature sensor corresponding to the zone. The system calculates the temperature offset based on the temperature detected by the sensor.
- Preset Room Temperature – No temperature sensor is needed, the room temperature is set to the preset temperature.

Monitoring sensors are only used to give a status of the temperature reading.

- Auxiliary Temperature Sensor – A thermistor sensor that may be externally or internally located in various locations.
- PSP Discharge – A thermistor sensor that monitors the discharge temperature in the Perforated Supply Plenum (PSP) section of the hood for Make-Up Air (MUA).
- ACPSP Discharge – A thermistor sensor that monitors the AC discharge temperature in the ACPSP section of the hood for cooling the space.
- Contact Monitoring – The ECPM03 board will monitor when the contactor pulls to activate the load (i.e. appliance, fan, lighting, etc.).
- Water Temperature Monitoring – A sensor used to monitor water temperature for self-cleaning systems used with CORE and on-board wash systems. The water temperature for wash should be between 140-170 degrees F for optimal performance. This setting can be monitored from the ECPM03 HMI, CASLink, or BMS.

Control sensors are used as feedback to the system on how to operate based on the fan zone configuration. The riser and capture sensor name will correspond to its location in the hood or plenum. These sensors may be assigned to a contactor zone or a VFD/PWM exhaust fan controller. Multiple sensors can be assigned to a specific motor or zone. The highest temperature reading will activate all the fans in a particular zone. If the zone is dynamic, the fan assigned to the variable controlled fan will modulate based on temperature associated with the assigned temperature sensor.

Additional Control Sensors for Defrost Control Activation (Hood Recovery Coil).

- **Hood Coil Input** – A thermistor sensor that monitors incoming water temperature on a hood recovery coil. If this temperature reaches the setpoint the system will go into HRC Defrost Mode.
- **Hood Coil Output** – A thermistor sensor that monitors outgoing water temperature on a hood recovery coil. If this temperature reaches the setpoint, the system will go into HRC Defrost Mode.

Fire Options

This sub-menu is Password protected (1234). **Changes should not be made after passing an inspection.**

Is Gas Valve Enabled? – This option will be enabled by default if the system is equipped with a CORE Fire Protection System. This option provides a **120V AC** signal, which is wired from the board, to control an electric gas valve. Shuts off in “critical conditions” when having gas flowing through the system could be dangerous.

Is Kill Switch Enabled? – This feature enables the KTS to activate as a kill switch or tamper switch input. The KTS input detects a loss of **120V AC**, which will de-energize the Kill Switch output (KS), de-energize the gas valve output and energizes the **120V AC** shunt trip.

Is CORE Enabled? – If a CORE Fire Protection System is connected to the DCV system, alarms from the CORE system will automatically be displayed on the HMI. Multiple CORE systems can be connected to the same DCV system. Refer to the CORE Manual for setup of CORE Interlock Network addressing to prevent communication conflicts. When the CORE system is left in test mode for more than 15-minutes the shunt trip will energize, the kill switch will de-energize, and the gas valve will de-energize to shut off the gas supply.

CORE Zone Assignment – Available if CORE is enabled. Up to 15 CORE boards can be assigned. The zones are configurable through on the CORE Board. Refer to the CORE manual for setup.

CORE Ansul Wash – If CORE is enabled, then this option will be available. This option is based on whether an Electric Wet Chemical system includes self-cleaning. If the Electric Wet Chemical package with the self-cleaning option is available, this option is set to Yes. If the Electric Wet Chemical package does not include self-cleaning, this option is set to No.

All Zones On During Wash – When a system uses one CORE wash zone and two fan zones, this option must be enabled. With this option, both zone exhaust VFDs and ECMs will run at wash speed defined in fan configuration.

Shunt Follows Fans? – If this option is enabled, the shunt trip will be energized whenever the fans are off. This is meant to prevent electric cooking appliances from running when the fans are off and is only required in some jurisdictions.

Does Gas Valve Follow Fans? – This option is visible when “Is Gas Valve Enabled” is set to Yes or CORE is enabled. If this option is enabled, the gas valve is shut off whenever the fans are off and requires a reset when the fans are turned on. This is meant to prevent gas cooking appliances from running when the fans are off and only required in some jurisdictions.

NOTE: Gas Valve Reset button on HMI must be pressed and appliance pilots must be relit after each fan cycle when this option is enabled.

Exhaust During Fire – When Max Speed is set, the exhaust fans will be turned on in a fire condition at their maximum speed. When Continue is set, the exhaust fans will stay in whatever state they were before the fire condition. When off is set, the fans will not be active during a fire condition.

Supply During Fire – When this option is turned off, the supply fans will be turned off in a fire condition. When Max Speed is selected, the supply fans will turn on in a fire condition.

Lights During Fire – When this option is set to “CONTINUE,” the lights will continue their state during a fire. If the option is set to “OFF,” the lights will turn off during a fire.

Menu Tree

NOTE: If the default option is not specified, the default is factory set.

Board Settings - Options

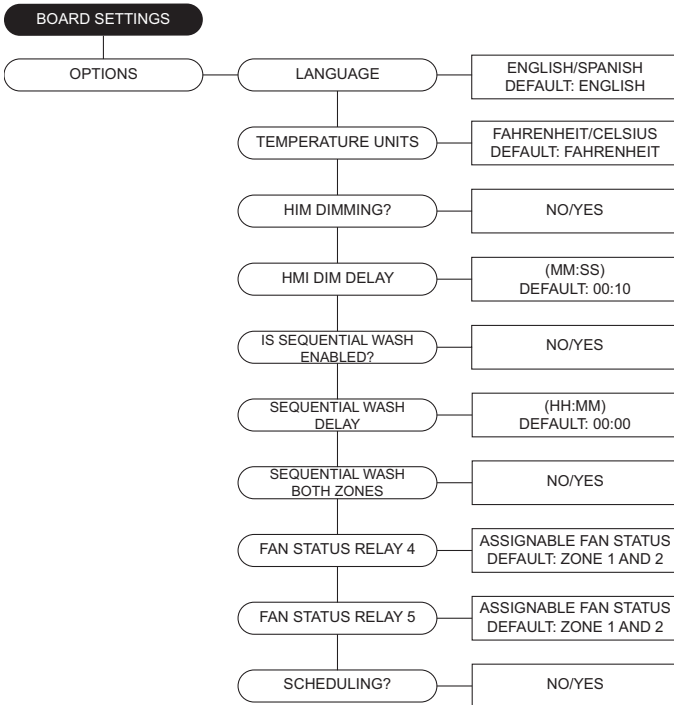

Motor Control - Fan Zone set to Dynamic

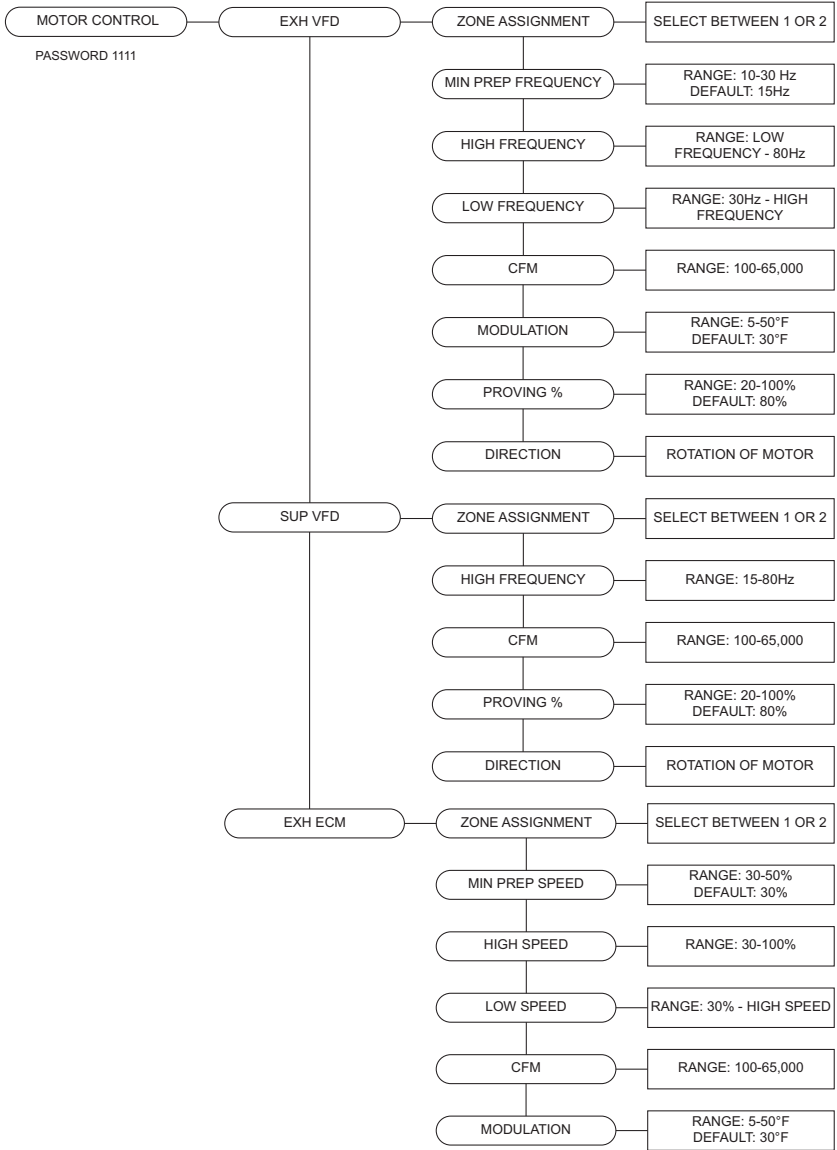

Motor Control - Fan Zone set to Dynamic

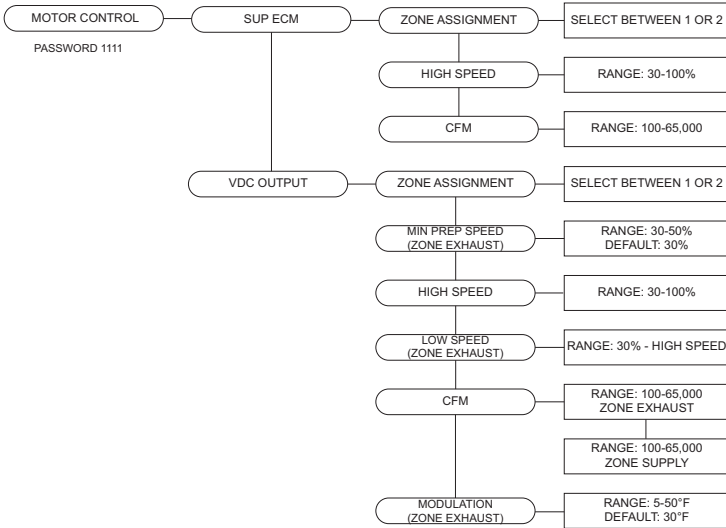

Motor Control - Fan Zone set to Static

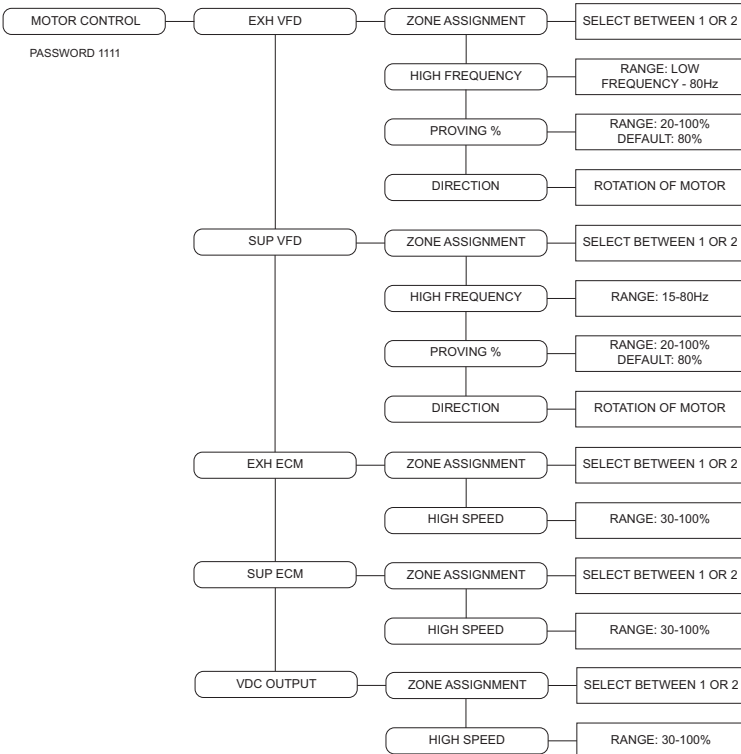

Factory Options

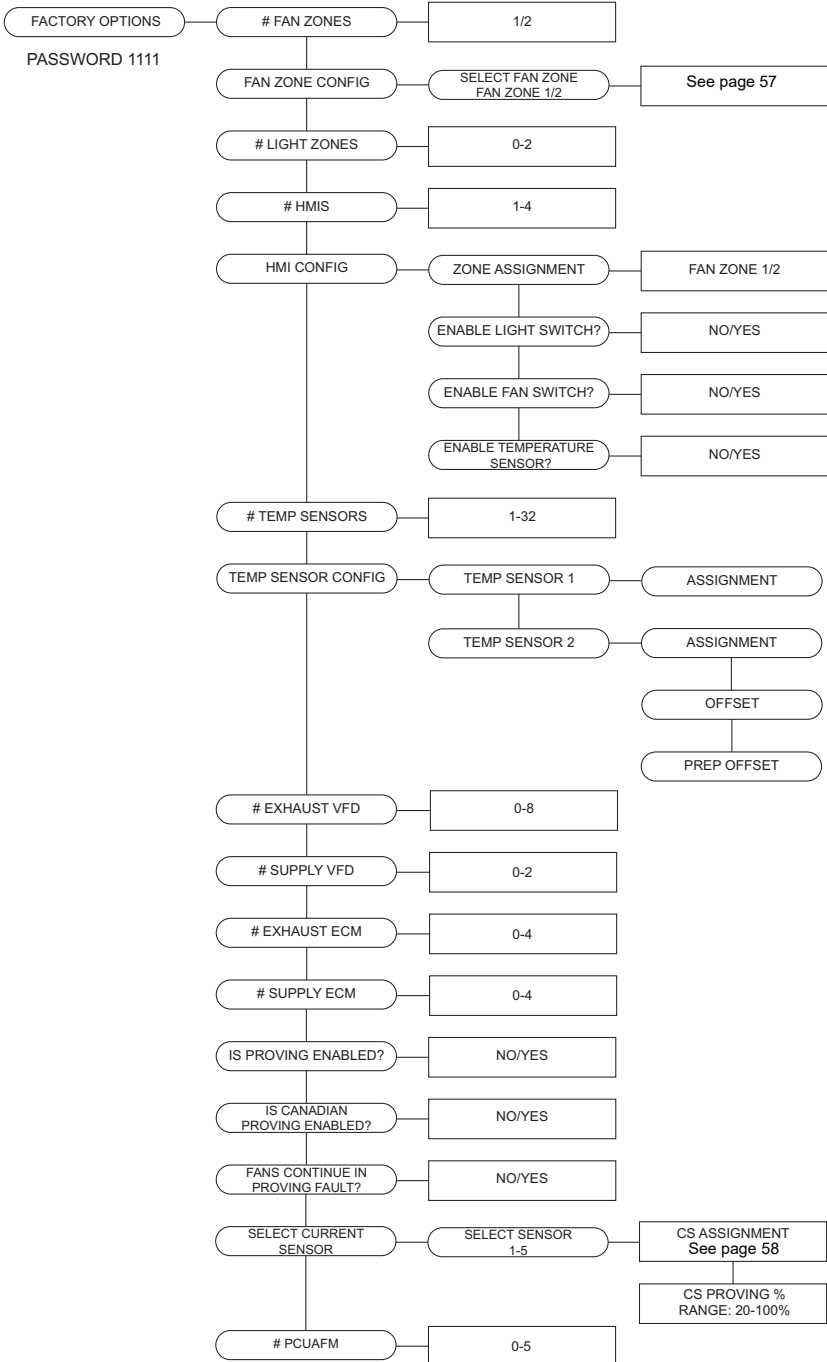

Factory Options

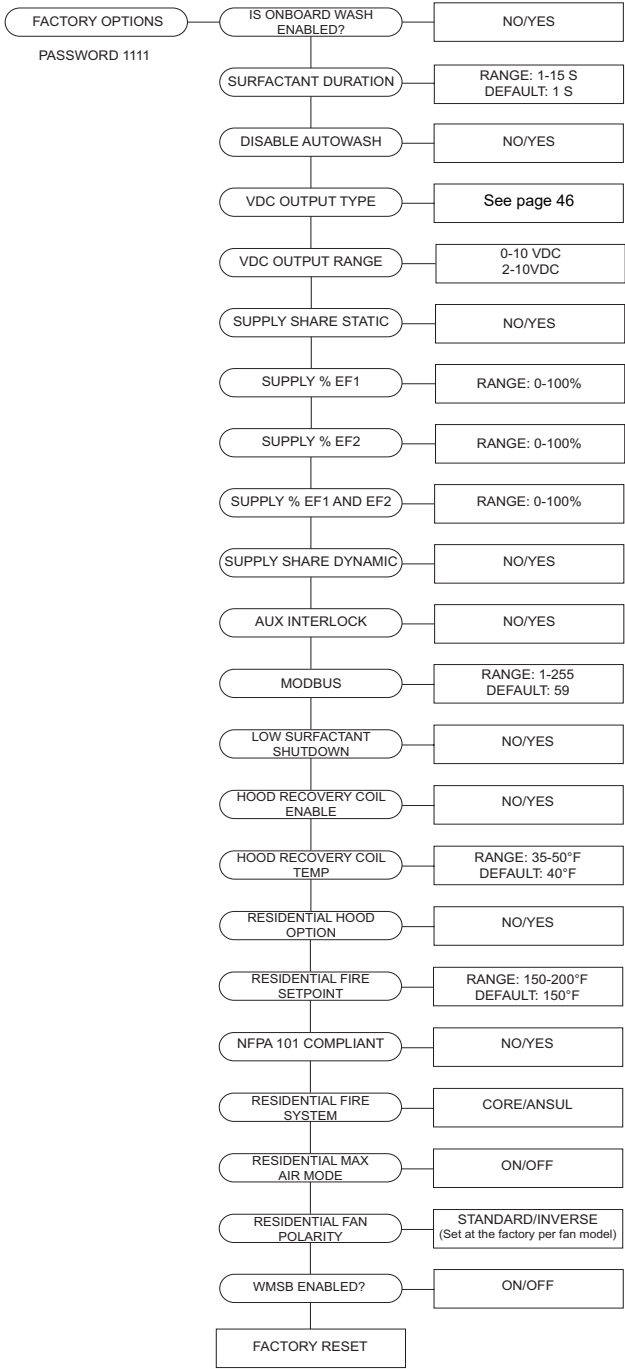

Fire Options

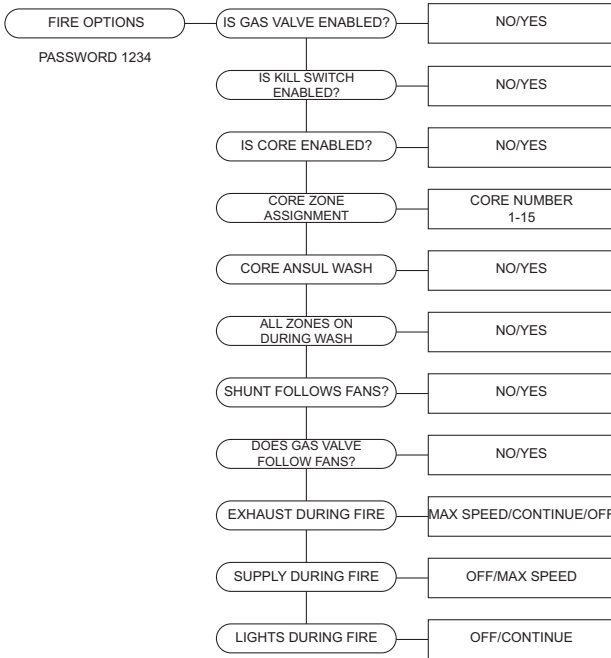

Prime Surfactant



Scheduling

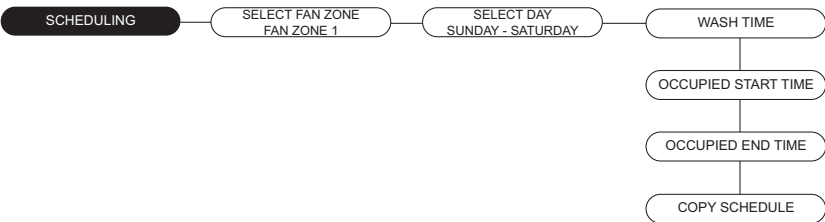

Light Brightness



Diagnostics

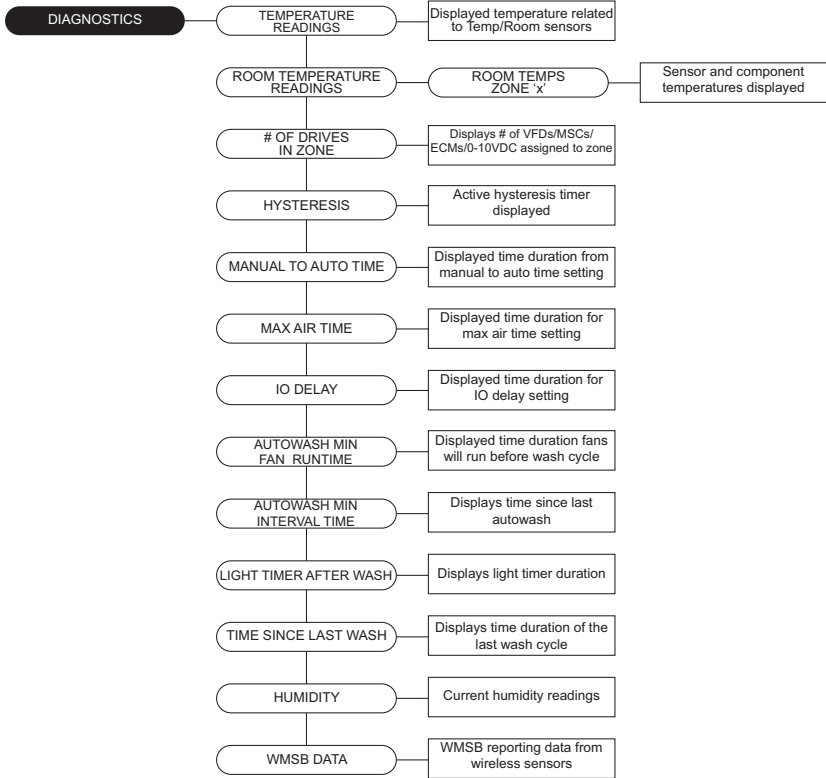

Selectable Fan Zone Options

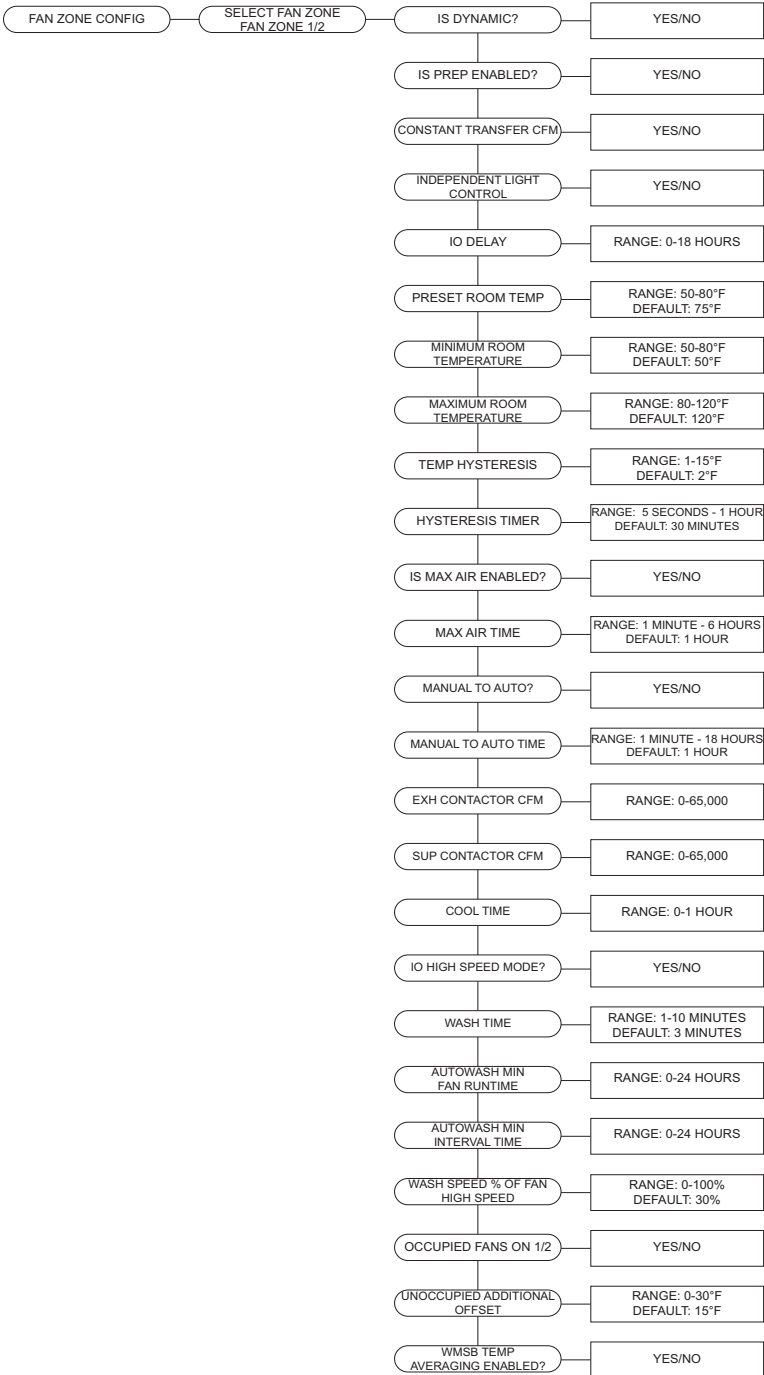

Scheduling (Fans)

Verify scheduling is set to Yes, see **“Scheduling” on page 65**. For setting a schedule, see **“Occupancy Schedule” on page 66**

Occupied Time

- The user may select between three different schedules (A, B, C).
- When the fans are set to operate in the occupied time setting, they will run in modulation mode if “Occupied Fans On” is enabled. When the “Occupied End Time” is reached, the fans will run based on temperature.

Unoccupied Time

- The user may select between three different schedules (A, B, C).
- During unoccupied time, the fans turn on at a higher offset to prohibit fans from turning on during an unwanted time.

To adjust the offset, see **“Unoccupied Additional Offset” on page 71**.

Proving Enabled (Optional)

(i.e. Loss of Load Interlock/Airflow Fault Interlock)

This function is designed so that if the supply or exhaust fans are not operating properly, all fans will shut off. Also, any gas valves or shunt trips in the system will shut off cooking equipment connected to the ECPM03 board.

If the “Proving Enabled” option is set to Yes, Calibration is required at start-up. Before calibration, verify the current sensor(s) are set properly in the HMI, refer **“Menu Tree” on page 50**.

- When using the CS Assignment option, assign current sensor(s) to one of the following selections: Zone 1/2 Exhaust, Zone 1/2 Supply, ECM 1-4, MSC Exhaust 1-8, MSC Supply 1-2, or Unassigned.
- If the CS Assignment will not be used, set to Unassigned.
- When using CS %, set percentage to desired value based on proving sensitivity.

To perform the calibration process:

- Make sure a “Test and Balance” has been performed on the entire system first.
- Verify that the filters are in place.
- Verify that the current sensors are assigned to the correct drive type.
 - Contactor current sensors are assigned as Zone X Exhaust or Zone X Supply where the “X” variable represents the zone number.
 - PWM controlled motors are assigned as the PWM reference number on the circuit board. For example, if current sensor 2 is monitoring motor circuit controlled by P2A and P2B, then current sensor 2 is assigned as ECM 2.
 - MSC Exhaust X and MSC Supply X where the “X” variable represents the fan number.
- ECPM03 Board: Starting from the main menu, press DOWN until the screen displays “Proving.” Press ENTER. The screen should display “Calibrate System?” Press ENTER to start the calibration process which can take 2 minutes and 30 seconds. Press MENU once when calibration is complete.
- HMI: Enter the configuration menu. Scroll to “Proving,” press ENTER. “Calibrate System?” will be displayed, press ENTER. The calibration process will start. Monitor the screen.
- Make sure the VFDs are running, ECM or contactor controlled motors are running, and the Make-Up Air (MUA) interlock signal is wired correctly to ILxA ILxB.

When enabled, the load on all the exhaust and supply fans is constantly monitored. If the load for an exhaust fan or the load for a supply fan drops below the threshold calculated after initial prove for approximately 15 seconds, all exhaust and supply fans will shut down.

If proving is enabled:

- **Is Proving Enabled?** – The supply fan and exhaust fan will activate simultaneously. After start-up, the system will take 90 seconds to detect a proving fault. Once the fans have proven, the timer switches to 15 seconds to detect loss of load.
- **Is Canadian Proving Enabled?** – First, the supply fan will activate, the fan will operate for 2 minutes to prove. If the supply fan proves, the exhaust fan will activate. The exhaust fan will take an additional 90 seconds to detect a proving fault. Once the fans have proven, the timer switches to 15 seconds to detect loss of load.
- **Fans Continue In Proving Fault?** – Yes/No option. When enabled On, loss of signal between MUA interlock will not stop the fans from operating.

The system sequence for Proving will be:

- The supply fan signal is activated to open dampers. If there are supply contactors, they will also be activated.
- When the interlock contacts close, all supply and exhaust fans will start on assigned zone.
- The system will have a maximum of 90 seconds to prove exhaust fans and supply fans.
- Once the fans have ran past their threshold, the system will monitor for a loss of proving. If there is a loss of proving, this will trigger a timer. If there is a loss of proving for 15 consecutive seconds, a proving fault will occur.

The system sequence for Canadian Proving will be:

- The supply fan signal is activated to open dampers. If there are supply contactors, they will also be activated.
- When the interlock contacts close, all supply fans on a zone will activate.
- The system will have a maximum of 120 seconds to prove a supply fans on the zone.
- Once all supply fans on the zone have passed their calibrated threshold, all exhaust fans on the zone will activate.
- Each zone will have a maximum of 90 seconds for each exhaust fan to prove.
- Once the fans have ran past their threshold, the system will monitor for a loss of proving. If there is a loss of proving, this will trigger a timer. If there is a loss of proving for 15 consecutive seconds, a proving fault will occur.

A few examples of why a fan would not be operating are: overload tripped, broken fan belt, defective motor, disconnect switch off, etc.

To reset the system after a proving fault, press the **Fault Reset** button on the HMI.

Fan Control

The control panel controls fans through outputs EF1, EF2, SF1, SF2, PWM outputs, 0-10V DC outputs, and VFDs. Each panel may be configured to utilize one or more of the above fan control methods.

Sample Temperature calculations:

An example of a typical application that the system will use to operate.

Average Room Temperature: 75

Temperature Sensor Prep Offset: 5

Temperature Sensor Offset: 10

Fan Zone Hysteresis: 2 (hysteresis for each fan zone)

Fan Zone Operating Range: 25

Preparation Activation Temperature: $75+5 = 80$

Activation Temperature: $75+10 = 85$

Hysteresis Temperature: $85-2 = 83$

Maximum Temperature: $85+25 = 110$

Temperature Range: 85 to 110

Static Fan Zone

Figure 29 displays the HMI screen state when fans are active.

Fans will activate when:

- The unshaded **FANS** button is pressed, the button will then turn shaded.
- If a temperature sensor assigned to the zone reads activation temperature.
- IO input, BMS, or Scheduling is activated.

When fans are in Activation Mode:

- Exhaust fans run at the constant motor speed defined. Fans will run at this constant speed as long as temperature is above the hysteresis setting.
- The system will stay in activation mode at a minimum for the defined hysteresis timer.

Fans will turn off when:

- Pressing the shaded **FANS** button will turn off the fans, unless the previous mode settings are still active (Fans by Temp, IO, BMS, Scheduling).
- The hysteresis timer is satisfied and the temperature is below the hysteresis setting.
- Fan control can be turned to Auto Mode if fans were turned on manually (by button) and automatically (temperature is above the activation temperature).

Figure 29 - Static Mode Activation

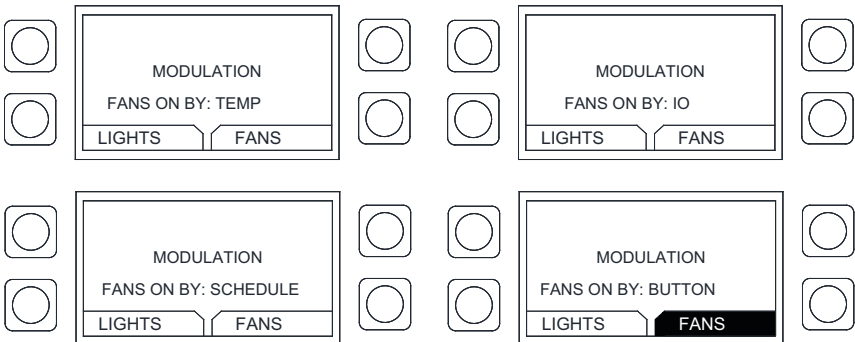

Dynamic Fan Zone

Figure 30 displays the HMI screen state when the fans are in prep mode.

Fans will go into PREP MODE when:

- **FANS** button is pressed
- Temperature sensor assigned to the zone reads Preparation Activation Temperature.

Fans Operation in PREP MODE:

- The system will stay on for the minimum hysteresis timer. After the hysteresis timer is satisfied, the system can drop down to Fans Off Mode, if the temperature is below Preparation Hysteresis Temperature.
- When fans are in Preparation Mode (exhaust fans run at calculated Preparation Mode Frequency, supply fans are turned off). Any fans in the same zone controlled by a contactor will not activate.

Figure 30 - Prep Mode

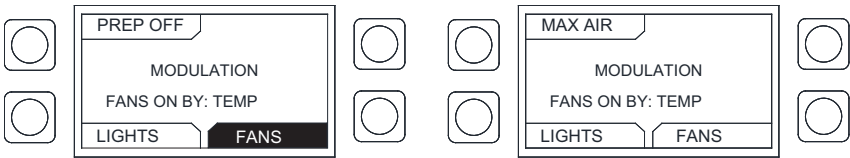

Fans will activate in modulation when:

Figure 31 displays the HMI screen state when the fans are in modulation.

- Pressing **PREP OFF** sends the system into modulation mode.
- If Preparation Mode is disabled, and if a temperature sensor assigned to the zone reads activation temperature, the fans will go into modulation mode.
- IO input

Fans Operation in modulation mode:

Exhaust fans run at dynamic modulation temperature calculation as long as the temperature is between the temperature range settings.

Figure 31 - Modulation Mode

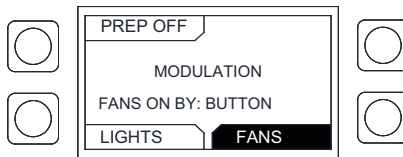

Fans will go out of modulation mode when:

- After the hysteresis timer is satisfied, the system will drop to Cool Down Mode (**Figure 32**), if Prep is enabled, or to **FANS** mode if the temperature is below hysteresis temperature setting.
- Fans can only be turned off in modulation mode if there is insufficient heat under the hood to maintain the fan activation temperatures.

Figure 32 - Cool Down Mode

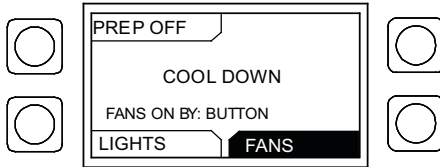

Fans in AUTO MODE when:

- Fans can be turned to **AUTO MODE** if fans were turned on manually (by button) and if the temperature is above the activation temperature.
- If a **FANS** button is not present, the fans are in Auto Mode. The fans will only be controlled by temperature sensors.

When fans are in Maximum Air Mode:

- If Max Air is enabled, a **MAX AIR** button (**Figure 33**) will appear. If pressed, this will send the system into Maximum Air Mode.
- Exhaust and supply fans will run at high speed.

Figure 33 - Max Air



Other Options

Make-Up Air Interlock

When the dedicated supply fan is a tempered make-up air unit, the blower inside the supply unit can be interlocked. The interlock must be closed for the supply fans to run. The unit will not run unless the safety controls (freezestat, smoke detector etc.) inside the supply fan are armed, and the internal motorized damper has reached its end limit switch. When the interlock is open, the supply VFDs or PWM/0-10V DC signal will shut off corresponding to their interlocked zone. An alarm will appear on the HMI if the signal from the make-up air is not received by the ECPM03 in ninety seconds (factory default) after the start signal is sent to the supply fan. If this fault occurs, the SF signal will de-energize. If proving is enabled, then the exhaust fans will not operate when the interlock is open.

The panel ships with a jumper wire between terminals IL1A and IL1B for all supply fans on Zone 1, and IL2A and IL2B for all supply fans on Zone 2. The jumper has to be removed first before wiring the interlock from a make-up air unit. Supply share static and dynamic only require a make-up air interlock on IL1A and IL1B.

Appliances Pilot Check Warning

Every time an electronic gas valve is reset, a warning message will be displayed on the HMI for 1 minute. A **CLEAR** button will be displayed on the HMI to clear the warning message and stop the beeps. The message disappears after 1 minute when the clear button is not pressed. This message is normal and provided as a reminder only. There is no need to take any action.

120V AC BMS Dry Contact (Optional)

All controls are equipped with the ability to control the fans via a dry contact BMS interlock. Terminal IO1 should be energized by closing a dry contact placed between terminals H1 and IO1. Removing the signal from IO1 will typically cause the fans to turn off. However, if the thermostat sensors are hot or if the fans are energized through the fan button on the HMI, then the fans will continue to run.

NOTE: If the panel is ordered with a digital building management option, such as CASlink, BACnet, or LonWorks, please refer to the Building Management Owner's Manual for alternative fan interlock scheduling.

Electric Gas Valve Reset

If the gas valve option is turned ON, an additional button (**GAS RESET/GAS ON**) will be displayed on the HMI to allow the user to reset or re-energize an electric gas valve connected to the panel. The gas valve is de-energized at initial start-up, when the fire system is triggered or in other conditions as well.

If the gas valve is enabled, then the **GAS RESET** button will be present. Once the **GAS RESET** is pressed, the **GAS ON** button will appear.

Wash Self-Cleaning (Optional)

The two types of self-cleaning options available are Onboard, and CORE. On-board should only be utilized for W1, and WL option panels.

During the wash cycle, water will be sprayed in the plenum and duct. Surfactant is injected once per minute during the wash cycle. The wash frequency is the value at which all exhaust fans will run in a wash mode. The supply fan will be stopped during wash when set to static zone. Refer to **Figure 34** for wash sequence displays.

Figure 34 - Wash Screens

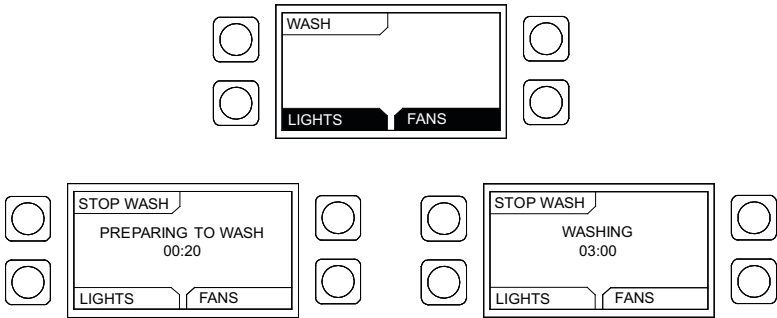

NOTE: The fan frequency will change when the zone is set to dynamic. See “Factory Options” on page 43.

The wash cycle will stop when the wash timer expires or when the **STOP WASH** button is pressed again.

The wash timer is factory set to 3 minutes and is adjustable through the menu. The surfactant is injected for 1 second at the start of each minute of wash (the surfactant injection time can be increased to 15 seconds).

Hood filters MUST remain in place during the wash cycle.

The wash cycle can be initiated in several ways:

- **Manually** - When the **WASH** button is pressed on the HMI.
- **Automatically** - If all of these conditions are met:
 - Fans will need to go out of modulation mode by the duct temperature cooling down and the hysteresis value and timer are met.
 - The fans will need to have effectively run cumulatively for an amount of time longer than the “Fan Runtime (H).” The (H) value is Hours for this option.
 - The amount of time elapsed since the previous wash cycle is greater than the “Interval Time” value. The (H) value is Hours for this option. That elapsed time is reset to zero when the wash cycle is active.

NOTE: Preparation/Cool Down mode fan time does not count toward the runtime. The wash timers are reset to zero when the wash cycle is activated.

- **Building Management System** - Refer to the Building Management Owner’s Manual for more information.
- **Scheduled Wash** - Refer to “**Setting Wash Schedule**” on page 68.

If the surfactant level is too low, an alarm will be triggered on the HMI. If the wash cycle is initiated while this alarm is active, water will be sprayed, but no surfactant will be injected. Refill surfactant as soon as possible for best results. (Refer to Self-Cleaning or CORE Manual for additional information).

Prime Surfactant

The prime surfactant option is only visible when “Onboard Wash” is enabled to Yes. When using the surfactant prime option, the surfactant pump will operate for 15 seconds. This will allow the user to test that the pump is operating properly.

Scheduling

When scheduling is enabled, this will allow the user to set a schedule for the fans and wash system to run on various days and at various time settings. The selectable settings are Wash Time/Occupied Start Time/Occupied End Time/Copy Schedule. First, select a day to start your schedule. Occupied Start Time and Occupied End Time will have three schedules available.

- **Wash Time** – Options for wash time are Disabled or setting a time (12:00 AM-11:55 PM). When creating a scheduled wash, start your wash time for when the appliance(s) are not in use.
- **Occupied Start Time** – Set your start time for when the appliance(s) will be in use. The settings available are Disable or setting time (12:00 AM-11:55 PM).
- **Occupied End Time** – Set your end time for when the appliance(s) will no longer be in use. The settings available are Disabled, a time (this range is based on the start time, you cannot set this time before the “Occupied Start Time”), or Next Day. If setting a schedule past 11:55 PM, use “Next Day” to continue the schedule overnight.
- **Copy Schedule** – This allows the user to copy a set schedule from one day to the next, set a schedule to weekdays or all days.

Enable Scheduling

1. Press the two top buttons at the same time to enter configuration mode.
2. “Board Settings” is the first screen to appear. Press **ENTER**.
3. “Options” will be the next screen. Press **ENTER**.
4. Use the **UP** or **DOWN** buttons to scroll to “Scheduling?” (**Figure 35**).
5. Verify “Scheduling?” is set to YES. If it is set to NO, select YES.

Figure 35 - Enabling Schedule

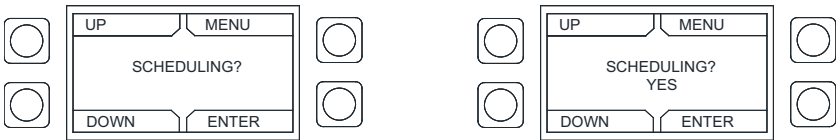

Occupancy Schedule

1. Setting an occupancy schedule will control when the fan(s) and wash cycles start and stop.

NOTE: Temperature sensor readings can still drive the automatic operation of the system.

2. Enter configuration mode to set an occupancy schedule.
3. Scroll to "Scheduling" (**Figure 36**). Press **ENTER**.
4. The next screen, you may select "Fan Zone 1" or "Fan Zone 2". Use the **UP** or **DOWN** buttons to select zone. After selecting which zone you want to set, press **ENTER**.
5. The next screen will allow you to select what day to set the schedule for. Use the **UP** or **DOWN** buttons to select a day (Sunday – Saturday).
6. The "Loading..." screen will appear.

Figure 36 - Occupancy Schedule

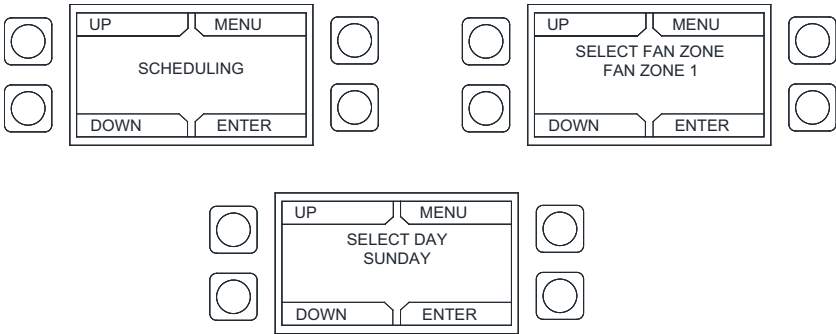

7. The next screen will display "Wash Time" as the first selectable option. Other options available on this screen:
 - Occupied Start Time
 - Occupied End Time
 - Copy Schedule
8. Set start time. Scroll to "Occupied Start Time."
9. Choose a schedule. You may select three different schedules.
 - Schedule A
 - Schedule B
 - Schedule C
10. This will allow the user to set various schedules. The user may set schedules for morning, afternoon, or evening use.
11. The default "Occupied Start Time" (**Figure 37**) varies on which schedule you select.
12. Use the **UP** or **DOWN** button to set your time.
13. The range setting: Disabled - 11:55 PM.

Figure 37 - Start Time

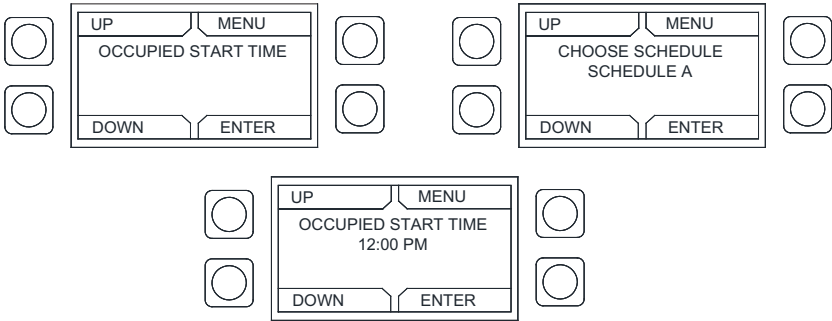

14. Set end time (**Figure 38**). Once the occupied start time is set, the user must set an end time.
15. Select schedule (A, B, C).
16. The range setting: Disabled - Next Day.

NOTE: When using "Next Day," set the next day start time to 12:00 AM.

Figure 38 - End Time

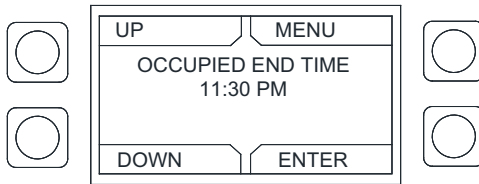

Setting Wash Schedule

1. To set a wash schedule, enter configuration mode.
2. Scroll to “Scheduling.” Press **ENTER**.
3. The next screen, you may select fan zone 1 or fan zone 2.
4. Use the **UP** or **DOWN** buttons to select zone. After selecting which zone you want to set, press **ENTER**.
5. The next screen, you may select what day you want to set for a schedule.
6. Use the **UP** or **DOWN** buttons to select a day (Sunday – Saturday).
7. The “Loading...” screen will appear.
8. Select “Wash Time” (**Figure 39**).
9. Set the time you want the wash to start. You cannot set a wash time if the system is in an occupied time setting. If a scheduled wash is active, automatic washing is disabled. Scheduled washes should ideally be set at a time just after cooking operations have completed, and the duct and plenum are still warm.
10. You may hold the **UP** or **DOWN** button to fast scroll.
11. The range setting: Disabled - 11:55 PM.

Figure 39 - Wash Schedule

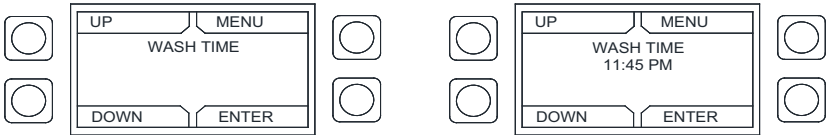

Copying a Schedule

1. Before copying a schedule, verify that the proper day, schedule, start time, end time, and wash time are set.
2. Scroll to “Copy Schedule” (Figure 40). Press **ENTER**.

Figure 40 - Copy Schedule

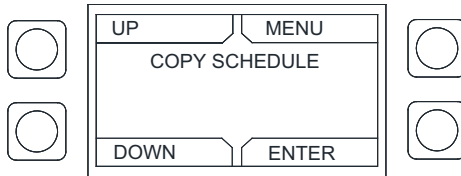

3. Determine what schedule to copy (Figure 41). Scroll through the selectable options:
 - Day to Day
 - Day to Week Days
 - Day to All Days
4. Day to day should be used if the schedule is the same for specific days but not for all. For example: If the equipment is operated at the same time on Monday, Wednesday, and Friday, copy Monday's schedule to Wednesday and then to Friday. Set the proper schedule for the other days.
5. Day to weekdays should be used if the schedule is the same throughout the weekdays (Monday – Friday). Using this option will not set a schedule for Saturday or Sunday.
6. Day to all days should be used if the schedule is the same for all days (Sunday – Saturday).

Figure 41 - Picking Schedule

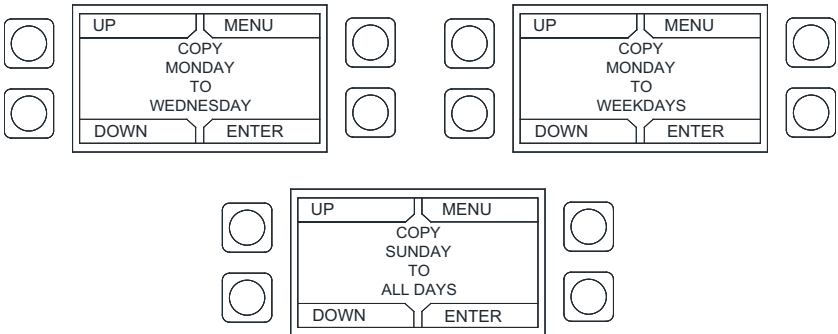

7. When copying a schedule (Figure 42), the HMI will display “Copying” then “Copy Complete.”

Figure 42 - Copying Schedule

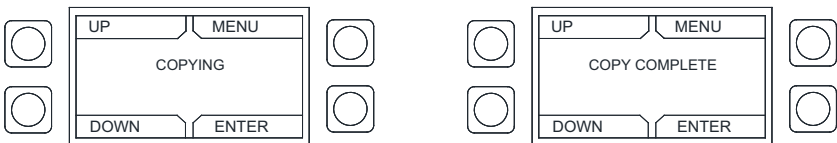

Setting a Continuous Schedule

When setting a continuous schedule (**Figure 43**), verify that the proper day, schedule, start time, end time, and wash time are set for your initial start day.

When using the “Next Day” setting, verify that the “Occupied Start Time” for the next day is set to 12:00 AM, then set the “Occupied End Time” for that day.

For example, to set a schedule from 8:00 AM to 2:00 AM (next day), set the following:

Monday

- Occupied start time A = 8:00 AM
- Occupied end time A = Next Day

Tuesday

- Occupied start time A = 12:00 AM
- Occupied end time A = 2:00 AM

Figure 43 - Continuous Schedule

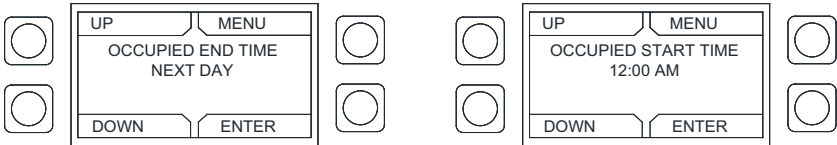

Setting a Fan Schedule

1. Press the two top buttons at the same time to enter configuration mode.
2. “Board Settings” is the first screen to appear. Press **ENTER**.
3. Use the **UP** or **DOWN** buttons to scroll to “Factory Options.” Enter Password 1111. Press **ENTER**.
4. Scroll to “Fan Zone Config.” Press **ENTER**.
5. Scroll to “Select Fan Zone 1/2.” Select which zone you want to set up. Press **ENTER**.
6. Scroll to “Occupied Fans On” (**Figure 44**). Press **ENTER**.
7. Verify “Occupied Fans On” is set to YES. If it is set to NO, select YES.
8. The fan(s) will operate during the start time and end time settings.
9. When the fan(s) are operating in an occupied setting, they will run in modulation mode when “Occupied Fans On” is enabled.

Figure 44 - Fan Schedule

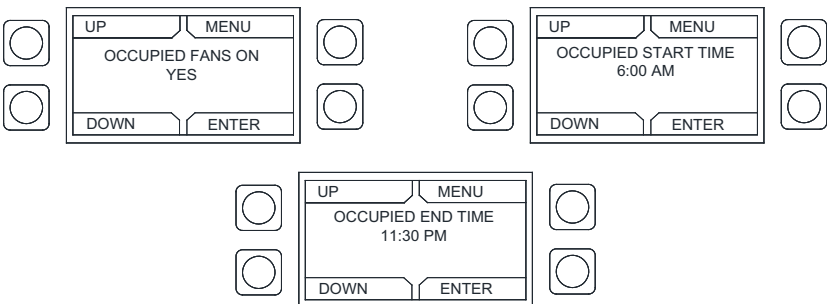

Unoccupied Additional Offset

1. Fan schedule must be enabled. Press the two top buttons at the same time to enter configuration mode.
2. "Board Settings" is the first screen to appear. Press **ENTER**.
3. Use the **UP** or **DOWN** buttons to scroll to "Factory Options." Enter Password 1111. Press **ENTER**.
4. Scroll to "Fan Zone Config." Press **ENTER**.
5. Scroll to "Select Fan Zone 1/2." Select which zone you want to set up. Press **ENTER**.
6. Scroll to "Unoccupied Additional Offset" (**Figure 45**). Press **ENTER**.
7. Adjusting the unoccupied offset allows the user to add an unoccupied offset temperature range on top of the other system offset settings. The default temperature setting is 15.0°F. This setting is adjustable from 0-30°F.
8. The fans turn on when the temperature exceeds the additional unoccupied offset during an unoccupied time. The "Unoccupied Offset" prevents false fan activation during an unoccupied time range.

Example: If the Room Temperature is set to 75°F, the Temperature Sensor Offset is set to 10°F, then the user sets an Unoccupied Offset of 15°F, the fans will turn on at 100°F in an unoccupied time range. If your hysteresis value is set to 2°F, the fans will shut off when the temperature drops to 98°F and the hysteresis timer has expired.

Figure 45 - Unoccupied Offsets

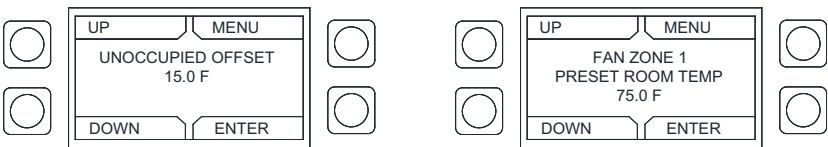

Light Brightness

This option is used on hoods that accept a 10V DC input signal, and maybe wired between two zones. When enabled through VDC Output Type, the light's brightness setting may be adjusted by entering the configuration menu and scrolling to "Light Brightness" or by pressing and holding the **LIGHTS ON** button for 3 seconds (**Figure 46**). The setting range is 10-100% and adjusts in increments of 5. Default is 100%.

The dimming control threshold varies between 0-10V and 2-10V. If the lights are not operating when set at a low percentage, try adjusting to a higher percentage before troubleshooting the system.

Figure 46 - Light Brightness

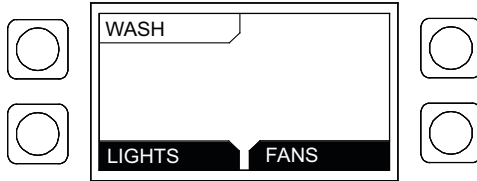

PWM 0-10V Board

The PWM 0-10V board (**Figure 47**) is an accessory board used with the ECPM03 board, and eliminates the need for providing a small horsepower VFD for jobs that require a 0-10V signal.

The 0-10V board is capable of providing up to four separate 0-10V signals, allowing the ECPM03 board up to five 0-10V output signals. The 0-10V board connector J1 will connect to the PWM outputs of the ECPM03 board at connector J10 terminals P1A through P4B. The 0-10V board will convert the PWM signal and output 0-10V signals at connector J2. There is a ground wire connection on the 0-10V board labeled VI(-) GND. This connection should be connected to the ECPM03 at connector pin VI(-). When the 0-10V board is in use, the ECPM03 board will no longer be capable of outputting PWM signals.

The Electronically Commutated Motor (ECM) percentage limits will convert to an equally limited 0-10V signal. For example, 50% = 5.0V. You must set the # of ECM fans to how many 0-10V signals will be utilized from this board.

Figure 47 - PWM 0-10V Board

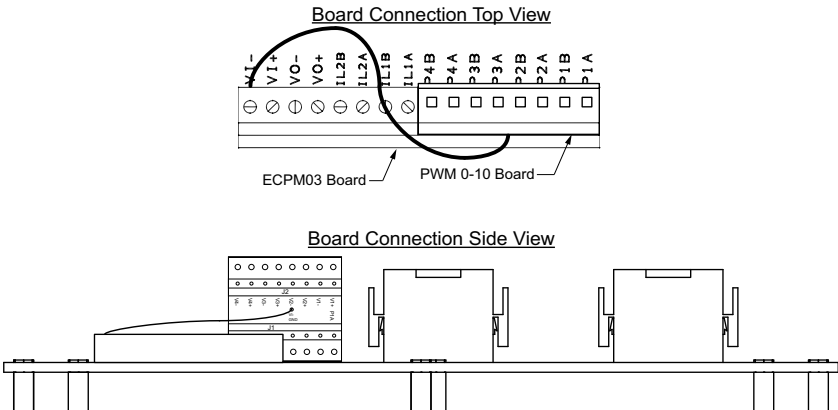

Diagnostics

If there is an issue with the system or certain parameters, use the HMI diagnostic menu to check settings. Using the diagnostic menu will help determine why or why not certain functions are working when they should not be or why certain functions will not work. Timers and system settings will override certain functions depending on the settings.

- Temperature Readings
- Room Temperature Readings
- # of Drive in Zone
- Hysteresis Timer
- Manual to Auto Time
- Max Air Time
- IO Delay
- Autowash Fan Runtime
- Autowash Min Interval Time
- Light Timer After Wash
- Time Since Last Wash
- Humidity (All sensor readings displayed)
- WMSB Data

Temperature Readings - This menu provides temperature readings for wired and HMI sensors connected to the package. If multiple sensors are attached, scroll through using the Up and Down buttons on the HMI.

WMSB Data - This menu provides temperature (°F), relative humidity (%), and barometric pressure (mBAR) readings for all WMSB connected to the package. Use the Up and Down buttons on the HMI to scroll through the readings. Displays number of remote units reporting in each zone.

Humidity Monitoring

If the electrical package is ordered with an HMI that is capable of monitoring humidity, the HMI will display the humidity percentage under the diagnostics menu. If the electrical package is ordered with an HMI that is not capable of monitoring humidity, the HMI will display N/A under humidity.

When installing an HMI to monitor the space's humidity, you must install in an area that is away from heat sources. Do not mount on hood, near cooking appliances or other heat-emitting sources. The humidity readings will not be accurate for that area.

TROUBLESHOOTING CONTROL PACKAGE

The following table lists causes and corrective actions for possible problems with this control package. Review this list before consulting manufacturer.

Problem	Potential Cause	Corrective Action
Smoke Rollout from Hood – Fans don't start-up when appliances are ON	Dirty temperature sensor	Clean grease and dirt from sensor.
	Poor heat detection	Decrease duct temperature offset values.
	Improper hood installation	Check for proper hood overhang, cross drafts, or improper hood design.
Fan(s) Spin in the Wrong Direction	3-phase motor output wired backwards	Swap 2 of the 3-phase wires on the output of the starter feeding the motor.
VFDs start On, then shut Off	Modbus fault	Check Modbus connections and VFDs.
Gas Valve Reset Does Not Show	Settings not configured properly in HMI	Refer to “Electric Gas Valve Reset” on page 63.
Dimming Lights Erratic	Dimming circuit setup	The minimum dimming control threshold may vary if using dimming control options by other manufacturers. Adjust the lighting control through the HMI and monitor the lighting brightness.
Fans Operating Overnight	Modulation offset too high	Lower the modulation offset for fans to trigger modulation at a lower temperature.
	Fans button by manual	Ensure cooking staff is deactivating fans at night.
Current Sensor - No readings	Faulty wiring/sensor	Confirm there is +12 to 30V DC in series with the current sensor output terminals and the analog input of the control panel.
		Check the polarity of the circuit.
		Verify that the terminals are secured, and wires are firmly in place.
		Disconnect the input to the control panel. Insert a current meter (mA range) in series with the current sensor output to verify that the circuit is working properly.

Problem	Potential Cause	Corrective Action
Current Sensor - Erratic readings	Faulty wiring/sensor	Verify that the wires are terminated properly.
		Check that the +12 to 30V DC input is clean. In areas of high RF interference, shielded cable may be necessary to stabilize signal.
Calibration Failure	Check fan power	Check there is power to fans.
		Check fan settings are configured to proper number in system.
		Check current sensor is assigned to proper motor type. Ensure all unused current sensors are marked as unassigned.
		Check that interlock closed from MUA.

WMSB Troubleshooting

If you experience issues with the sensor or charging, perform the following checks:

- Verify the sensor is within 10-15 feet of the electrical control package.
- Check that the sensor is receiving proper lighting on the solar panel. There should be approximately 200 lumens for the solar panel to function properly.
- Verify electrical connections from the solar cell to the board are properly connected.
- Verify the battery connection is connected to the board. This must be connected in the field.
- Check that there are no objects or any type of impedance to the sensor or lighting.
- Do not mount the sensor inside a cabinet.
- Verify the sensor is not installed inside the wall. The back of the sensor should be flush to the outside of the wall.
- When the battery is low, a fault will be displayed on the ECP HMI. Change battery.

HMI Fault Messages

The following table lists fault messages displayed on the HMI and corrective actions. Review this list before consulting manufacturer.

HMI Message	Potential Cause	Corrective Action
"Fire"	There is a fire condition or the fire circuit not wired properly.	If a fire is not present, verify connection between terminal blocks C1 and AR1.
"Light Fault Zone 1 Bx De-energized"	Light output is energized but no power is detected on terminal B1.	Verify the light relay is not damaged and that the light circuit breaker is not tripped.
"Light Fault Zone x B1 energized"	Light output is de-energized but power is detected on terminal B1.	Verify that the light relay contact is not welded in the closed position.
"Overload Zone x"	One of the overload relays for fans associated with zone 1 is tripped.	Reset overload relay. Monitor fan to see why overload tripped.
"Surfactant Low"	Surfactant level is low.	Refill surfactant into the tank. Refer to Self-Cleaning or CORE manual.
"PCU Fault"	PCU filters are clogged or missing.	Check PCU filters. If the filters are clogged or dirty, clean or replace if needed.
"Proving Fault"	Proving enabled. Exhaust fan not meeting its minimum calibrated load.	Verify fans are running properly.
		Verify proving calibration. Refer to " Proving Enabled (Optional) " on page 58.
"Fuse F1 Blown"	Fuse F1 is blown or missing.	Check for short circuit, and verify that the load is below 10 amps.
		Replace fuse.
"Temp Sensor x Not Connected"	Temperature sensor x is not wired to the ECPM03 board.	Verify proper wiring to terminals TxA and TxB on the board and wiring to the sensor.
		Check for faulty wiring or sensor.

HMI Message	Potential Cause	Corrective Action
"Modbus Communication Fault"	One or several components on the Modbus network are not responding.	Verify HMIs are plugged in.
		Verify CORE or PCU AFM are plugged in.
		Verify the configurations are set correctly.
		Verify Cat 5 connections. Check for damaged wiring or ends.
"CORE x Fault" Fault description	Specific fault is present on the CORE fire system.	Verify the CORE DIP switch settings are correct.
		Refer to CORE manual for specific fault description.
"PCU x Fault" Fault description	Specific fault is present on the PCUAFM x connected to the system.	Refer to the PCUAFM manual for specific fault description.
"ESP x Fault" Fault description	Specific fault is present on the PCUAFM x connected to the system.	Refer to the PCUAFM manual for specific fault description.
"Sup 1 Interlock" "Check MUA-1 Controls "	Interlock signal was not received back from the MUA.	Verify MUA is not faulted and damper is fully open.
		Verify Interlock is properly wired.
"Exh" or "Sup" "VFD Fault"	VFD fault on exhaust or supply.	Refer to the VFD manual for details.
"Temp Sensor x Bad Sensor"	Faulty temperature sensor due to overheating or internal failure.	Check for faulty wiring or sensor.
"Communications fault Check Configuration"	ECPM03 board and HMI not communicating due to: - Software incompatible - HMI # doesn't match number of zones	Re-flash the HMI
		Change HMI #
		Replace Cat 5 cable
		Replace EOL resistor
Invalid Activation	Voltage on CORE Board at Connector J3-7/J3-10	Check for external voltage being applied at J3-7 and J3-10.

VFD Fault List

Adjusting VFD parameters may cause other operating system issues. Improper handling of these devices may be dangerous. Only a trained service technician should work and make adjustments to the VFD and settings. Refer to VFD Manual for more information.

To reset faults, remove power until VFD display is blank. Refer to **Table 5** for common VFD faults. Refer to **Table 6 on page 79** for VFD fault list.

Table 5 - Common VFD Faults

Fault #	Fault Description	Potential Cause	Corrective Action
1	IGBT temperature fault	Drive is too hot inside	Reduce load to drive.
			Improve cooling.
			Verify control cabinet cooling fan operation and check air filter (If VFD is mounted in ECP).
			Verify VFD Internal cooling fan operation (3HP and above).
2	Output fault	Short circuit	Check motor/cable. (Megohmmeter may be necessary for proper diagnosis).
		Mechanical issue	Check system for mechanical issues.
		Excessive capacitive charging	Verify correct cables and wiring are used to the VFD. Install reactor between motor and drive.
		Acceleration time too short	Increase P104 (Accel Time). Adjustable from 0 Hz– base frequency (P167), refer to “ Variable Frequency Drive Parameters ” on page 13.
		Failed output transistor	Contact factory technical support.
3	Ground Fault	Grounded motor phase	Check motor/cable. (Megohmmeter may be necessary for proper diagnosis).
		Grounded wiring between VFD and motor	
4	Temperature fault	Drive is too hot inside	Reduce load to drive.
			Improve cooling.
5	Flying Start Fault	Over-current	Verify fan is not rotating at run command to VFD.
6	High DC bus	Main voltage too high	Check main voltage and P107, refer to “ Variable Frequency Drive Parameters ” on page 13.
7	Low DC bus	Main voltage too low	Check main voltage and P107, refer to “ Variable Frequency Drive Parameters ” on page 13.

Table 5 - Common VFD Faults

Fault #	Fault Description	Potential Cause	Corrective Action
8	Overload fault	Excessive motor load for too long	Verify proper motor rotation.
			Decrease the high-frequency setting.
			Adjust motor pulley to reduce load (if applicable).
			Check fan for mechanical issues (debris in fan wheel, motor failure, bearing failure, etc.).
			Verify P108 setting, refer to “ Variable Frequency Drive Parameters ” on page 13.
			Verify motor and drive are proper size for application.

Table 6 -VFD Drive Fault List

Fault Number	Description	Fault Number	Description
0	No Fault	12	Phase Lost
1	IGBT Temperature Fault	13	External Fault
2	Output Fault	14	Control Fault
3	Ground Fault	15	Start Fault
4	Temperature Fault	16	Incompatible Parameter Set
5	Flying Start Fault	17	EPM Hardware Fault
6	High DC BUS	18 - 27	Internal Fault
7	Low DC BUS	28	Remote Keypad Lost
8	Overload Fault	29	Assertion Level Fault
9	OEM Fault	30 - 33	Internal Fault
10	Illegal Setup Fault	34	Comm. Module Failure
11	Dynamic Brake Fault	35 - 44	Network Fault

Refer to VFD Manual for more information.

MSC Troubleshooting

Fault	Problem	Potential Cause	Corrective Action
Feedback Fault	Feedback Fault on MSC Display	Disconnected/faulty wiring.	Secure connections to fan. If faulty wiring is found, repair, or replace as required.
		No feedback for 30 seconds.	Check parameters.
		Less than 70% of RPM.	Check duct/fan for obstructions.
Modbus	Modbus fault on MSC Display	Faulty Cat 5 connection/cable.	Find and replace faulty cable.
		ECPM03 does not recognize device.	Verify Modbus # on device is set correctly.
Variable Device Fault	Motor not responding to changes made on variable device (potentiometer)	Defective potentiometer.	Replace potentiometer.
		Faulty wiring to motor.	Find and replace faulty wiring.
Motor not responding	Motor not functioning as expected	2-Speed switch not working.	Check switch and wiring.
		Wiring to motor defective.	Find and replace faulty wiring.
		Check for other faults on MSC display.	If no other faults are present, motor may be defective.

TURN OFF POWER TO THE MOTOR WHILE PROGRAMMING THIS DEVICE.

- If the device has a potentiometer or a 2-Speed switch, a jumper wire can be placed in between the 10V In and 10V Out terminals to rule out a defective device. This will cause the motor to go to HIGH SPEED.
- The IO STATUS menu can be used to verify the inputs and outputs of the device are functioning as expected.
- The FAULT HISTORY menu can be used to keep track of faults while working on the device.

MAINTENANCE

To guarantee trouble-free operation of this control, the manufacturer suggests following these guidelines. Most problems associated with unit failures are directly related to improper service and maintenance.

Please record any maintenance or service performed on this equipment in the documentation section located at the end of this manual.

WARNING: Do not attempt maintenance on this control until the electrical supply has been completely disconnected.

General Maintenance

1. Control enclosure should be kept clean and free from any grease or dirt build-up.
2. All fasteners should be checked for tightness each time maintenance checks are performed before restarting unit.
3. Control enclosure door panel should be securely closed after maintenance to prevent tampering or electrical shock.
4. Real Time Clock (RTC) battery should be replaced every 10 Years. Use CR2032 or equivalent.

Every Month

1. Temperature sensor(s) in exhaust hood riser(s) must be cleaned by removing any grease or dust build-up from the probe with a clean cloth. A clean sensor ensures that the temperature switch will quickly respond to changes in exhaust air temperature.
2. Check all fasteners, sensors, and electrical connections for proper tightness and continuity.

Wall Mounted Enclosure Fan Filter Inspection

1. Remove outer black plastic housing of the enclosure fan to gain access to the fan filter. The cover is held in place by frictional clips, simply pry on it to remove.
2. Inspect the fan filter for grease/debris. If the filter is dirty, clean, or replace.

Replacement fan filter part number: MC32658 (pack of 5).

WARNING: If fan filter cleaning is not performed, grease/debris buildup may occur, resulting in VFD failure due to overheating. VFD warranty may be denied if filter inspection is not performed monthly and logged on the maintenance record.

Self-Cleaning

Please refer to the Self-Cleaning, Electric Wet Chemical, or CORE Manual for Installation, Operation, and Maintenance of the self-cleaning system.

